

## Trademarks

Autel®, MaxiSys®, MaxiDAS®, MaxiScan®, MaxiCOM®, MaxiTPMS®, MaxiRecorder®, and MaxiCheck® are trademarks of Autel Intelligent Technology Corp., Ltd., registered in China, the United States, and other countries. All other marks are trademarks or registered trademarks of their respective holders.

## Copyright Information

No part of this manual may be reproduced, stored in a retrieval system or transmitted in any form or by any means electronic, mechanical, photocopying, recording, or otherwise without the prior written permission of Autel.

## Disclaimer of Warranties and Limitation of Liabilities

All information, specifications and illustrations in this manual are based on the latest information available at the time of printing.

Autel reserves the right to make changes at any time without notice. While information of this manual has been carefully checked for accuracy, no guarantee is given for the completeness and correctness of the contents, including but not limited to the product specifications, functions, and illustrations.

Autel will not be liable for any direct, special, incidental, or indirect damages, or for any economic consequential damages (including lost profits) as a result of using this product.

---

### **IMPORTANT**

Before operating or maintaining this unit, please read this manual carefully, paying extra attention to the safety warnings and precautions.

---

## For Services and Support:



[pro.autel.com](http://pro.autel.com)  
[www.autel.com](http://www.autel.com)



1-855-288-3587/1-855-AUTELUS (North America)  
0086-755-86147779 (China)



[support@autel.com](mailto:support@autel.com)

For details, please refer to the [Service Procedures](#).

# Safety Information

---

For your own safety and the safety of others, and to prevent damage to the device and vehicles upon which it is used, it is important that the safety instructions presented throughout this manual be read and understood by all persons operating or coming into contact with the device.

There are numerous procedures, techniques, tools, and parts required for servicing vehicles, as well as the skills of the person doing the work. Because of the vast number of test applications and variations in the products that can be tested with this equipment, we cannot possibly anticipate or provide advice or safety messages to cover every circumstance. It is the automotive technician's responsibility to be knowledgeable of the system being tested. It is crucial to use proper service methods and test procedures. It is essential to perform tests in an appropriate and acceptable manner that does not endanger your safety, the safety of others in the work area, the device being used, or the vehicle being tested.

Before using the device, always refer to and follow the safety messages and applicable test procedures provided by the manufacturer of the vehicle or equipment being tested. Use the device only as described in this manual. Be sure to read, understand, and follow all safety messages and instructions in this manual.

## Safety Messages

---

Safety messages are provided to help prevent personal injury and equipment damage. All safety messages are introduced by a signal word indicating the hazard level.

---

### DANGER

Indicates an imminently hazardous situation which, if not avoided, will result in death or serious injury to the operator or to bystanders.

---

---

## **WARNING**

Indicates a potentially hazardous situation which, if not avoided, could result in death or serious injury to the operator or to bystanders.

---

## **Safety Instructions**

---

The safety messages herein cover situations Autel is aware of at the time of publication. Autel cannot know, evaluate or advise you as to all of the possible hazards. You must be certain that any condition or service procedure encountered does not jeopardize your personal safety.

---

## **DANGER**

When an engine is operating, keep the service area **WELL VENTILATED** or attach a building exhaust removal system to the engine exhaust system. Engines produce carbon monoxide, an odorless, poisonous gas that causes slower reaction time and can lead to serious personal injury or loss of life.

---

---

## **Do Not Turn the Volume Up Too Loud When Using Headphones**

Listening at high volumes that over-stimulate the ear for long periods of time may result in loss of hearing.

---

## **SAFETY WARNINGS**

- Always perform automotive testing in a safe environment.
- Wear safety eye protection that meets ANSI standards.
- Keep clothing, hair, hands, tools, test equipment, etc., away from all moving or hot engine parts.
- Operate the vehicle in a well-ventilated work area.
- Put the transmission in **PARK** (for automatic transmission) or **NEUTRAL** (for manual transmission) and make sure the parking brake is engaged.
- Put blocks in front of the drive wheels and never leave the vehicle unattended while testing.
- Be extra cautious when working around the ignition coil, distributor cap, ignition wires and spark plugs. These components create hazardous voltages when the engine is running.

- Keep a fire extinguisher suitable for gasoline, chemical, and electrical fires nearby.
- Do not connect or disconnect any test equipment while the ignition is on or the engine is running.
- Keep the test equipment dry, clean, and free from oil, water, and grease. Use a mild detergent on a clean cloth to clean the outside of the equipment as necessary.
- Do not drive the vehicle and operate the test equipment at the same time. Any distraction may cause an accident.
- Refer to the service manual for the vehicle being serviced and adhere to all diagnostic procedures and precautions. Failure to do so may result in personal injury or damage to the test equipment.
- To avoid damaging the test equipment or generating false data, make sure the vehicle battery is fully charged and the connection to the vehicle DLC is clean and secure.
- Do not place the test equipment on the distributor of the vehicle. Strong electromagnetic interference can damage the equipment.

# Contents

SAFETY INFORMATION.....	ii
SAFETY MESSAGES .....	ii
SAFETY INSTRUCTIONS .....	iii
<b>1. USING THIS MANUAL .....</b>	<b>1</b>
CONVENTIONS.....	1
Bold Text .....	1
Notes and Important Messages.....	1
Hyperlinks .....	2
Illustrations.....	2
Procedures.....	2
<b>2. GENERAL INTRODUCTION .....</b>	<b>3</b>
MAXICOM TABLET .....	4
Function Descriptions.....	4
Power Sources .....	5
Technical Specifications.....	6
VCI — WIRELESS DIAGNOSTIC INTERFACE .....	7
Function Descriptions.....	7
Power Sources .....	8
Technical Specifications .....	8
VCI — J2534 ECU PROGRAMMING DEVICE .....	9
Function Descriptions.....	9
Power Sources .....	10
Technical Specifications .....	10
ACCESSORIES KIT .....	11
Main Cable.....	11
OBDI Adapters (Optional) .....	11
Other Accessories .....	12
<b>3. GETTING STARTED.....</b>	<b>14</b>
POWERING UP.....	14
Application Buttons.....	15
Page Control and Navigation Buttons .....	16
System Status Icons.....	18
POWERING DOWN.....	18

Reboot System .....	18
PRINTING .....	18
Installing Computer Software.....	19
<b>4. DIAGNOSTICS.....</b>	<b>20</b>
ESTABLISHING VEHICLE COMMUNICATION .....	20
Vehicle Connection.....	20
VCI Connection .....	22
No Communication Message.....	24
GETTING STARTED.....	25
Vehicle Menu Layout.....	25
VEHICLE IDENTIFICATION.....	26
Auto VIN Scan .....	27
Manual VIN Input.....	28
Scan VIN/License .....	29
Manual Vehicle Selection.....	31
Alternative Vehicle Identification.....	31
NAVIGATION.....	31
Diagnostics Screen Layout .....	31
Screen Messages.....	34
MAIN MENU.....	35
DIAGNOSIS .....	35
Auto Scan .....	36
Control Unit.....	37
ECU Information .....	38
Trouble Codes .....	39
Live Data.....	41
Active Test.....	47
Special Functions .....	48
GENERIC OBDII OPERATIONS .....	49
General Procedure .....	49
Function Descriptions.....	51
SERVICE.....	54
Function Descriptions.....	54
CODING.....	59
Variant Coding .....	60

EXIT DIAGNOSTICS .....	61
<b>5. DATA MANAGER.....</b>	<b>62</b>
VEHICLE HISTORY.....	63
Test Records.....	64
WORKSHOP INFORMATION.....	65
CUSTOMER.....	66
IMAGE .....	67
REPORT .....	68
PDF FILES.....	69
REVIEW DATA.....	69
DATA LOGGING .....	70
UNINSTALL APPS .....	70
<b>6. BATTERY TEST .....</b>	<b>71</b>
MAXIBAS BT506 TESTER.....	71
Function Descriptions.....	71
Power Sources .....	72
Technical Specifications .....	73
TEST PREPARATION .....	73
Inspect the Battery .....	73
Connect the Battery Tester .....	74
IN-VEHICLE TEST .....	75
Battery Test.....	76
Starter Test.....	78
Generator Test.....	79
OUT-VEHICLE TEST.....	80
Test Procedure.....	80
Test Results .....	81
<b>7. USER FEEDBACK.....</b>	<b>82</b>
<b>8. SETTINGS.....</b>	<b>83</b>
UNITS.....	83
LANGUAGE .....	84
PRINTING SETTINGS .....	84
SCAN REPORT.....	84
PUSH NOTIFICATIONS.....	85
AUTO UPDATE .....	85

VEHICLE LIST .....	86
SYSTEM SETTINGS .....	86
ABOUT .....	86
<b>9. UPDATE.....</b>	<b>87</b>
<b>10. VCI MANAGER.....</b>	<b>89</b>
VCI BLUETOOTH PAIRING .....	89
BAS BLUETOOTH PAIRING.....	90
VCI UPDATE.....	91
BAS UPDATE .....	92
<b>11. REMOTE DESKTOP.....</b>	<b>93</b>
OPERATIONS .....	93
<b>12. SUPPORT.....</b>	<b>95</b>
PRODUCT REGISTRATION.....	95
SUPPORT SCREEN LAYOUT .....	96
My Account .....	97
Training .....	97
Data Logging .....	97
FAQ.....	98
<b>13. QUICK LINK.....</b>	<b>99</b>
<b>14. MAXISCOPE .....</b>	<b>100</b>
<b>15. MAXVIEWER.....</b>	<b>101</b>
<b>16. MAXIVIDEO.....</b>	<b>103</b>
<b>17. OEM AUTHORIZATION.....</b>	<b>104</b>
<b>18. MAINTENANCE AND SERVICE.....</b>	<b>105</b>
MAINTENANCE INSTRUCTIONS .....	105
TROUBLESHOOTING CHECKLIST .....	106
ABOUT BATTERY USAGE .....	106
SERVICE PROCEDURES.....	107
Technical Support.....	107
Repair Service .....	109
Other Services.....	109
<b>19. COMPLIANCE INFORMATION .....</b>	<b>110</b>
<b>20. WARRANTY .....</b>	<b>112</b>
12-MONTH LIMITED WARRANTY.....	112



# 1. Using This Manual

This manual contains device usage instructions.

Some illustrations shown in this manual may make reference to modules and optional equipment that are not included in your system.

## Conventions

---

The following conventions are used:

### **Bold Text**

Bold text is used to highlight selectable items such as buttons and menu options.

Example:

- Tap **OK**.

### **Notes and Important Messages**

#### *Notes*

A **NOTE** provides helpful information such as additional explanations, tips, and comments.

Example:

---

#### **NOTE**

New batteries reach full capacity after approximately 3 to 5 charging and discharging cycles.

---

#### *Important*

**IMPORTANT** indicates a situation which, if not avoided, may result in damage to the tablet or vehicle.

Example:

---

**!** **IMPORTANT**

Keep the cable away from heat, oil, sharp edges and moving parts. Replace damaged cables immediately.

---

## Hyperlinks

Hyperlinks are available in electronic documents. Blue italic text indicates a selectable hyperlink and blue underlined text indicates a website link or an email address link.

## Illustrations

Illustrations used in this manual are samples, and the actual testing screen may vary for each vehicle being tested. Observe the menu titles and on-screen instructions to make correct option selection.

## Procedures

An arrow icon indicates a procedure.

Example:

➤ **To use the camera**

1. Tap the **Camera** icon. The camera screen opens.
2. Focus the image to be captured in the viewfinder.
3. Tap the **Camera** icon on the right of the screen. The viewfinder now shows the captured picture and auto-saves the taken photo.
4. Tap the thumbnail image on the top-right corner of the screen to view the stored image.
5. Tap the **Back** or **Home** button to exit the camera application.

# 2. General Introduction

The MaxiCOM®MK908 II/MaxiCOM®MK908Pro II Diagnostic Platform is an evolutionary smart solution for specialized automotive diagnosis. Utilizing the powerful octa-core processor, and a 10.1-inch LED capacitive touchscreen, combined with the best possible coverage of OE-level diagnostics, and based on the revolutionary multitask-capable Android 10 Operating system, the MaxiCOM organizes information with test instrumentation to help you diagnose symptoms, codes, and customer complaints easily, quickly, and efficiently.

There are two main components to the MaxiCOM system:

- MaxiCOM Tablet — the central processor and monitor for the system
- Vehicle Communication Interface (VCI) — the device for accessing vehicle data

---

 **NOTE**

Autel provides two optional VCIs for your choice. One is the Wireless Diagnostic Interface; the other is the J2534 Programming Device . Both will be introduced in this chapter.

---

This manual describes the construction and operation of these devices and how they work together to deliver diagnostic solutions.

# MaxiCOM Tablet

---

## Function Descriptions

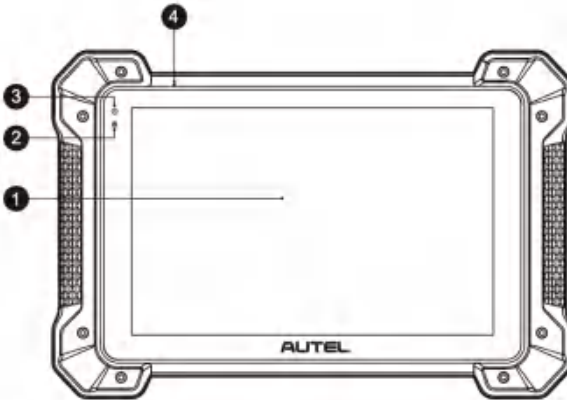

**Figure 2-1 MaxiCOM Tablet, Front View**

1. 10.1-inch Capacitive Touchscreen
2. Ambient Light Sensor — detects ambient light brightness
3. Power LED — indicates battery level & charging or system status
4. Microphone

The power LED displays green, yellow or red depending on power level and operating state.

A. Green

- Illuminates green when the tablet is charging and the battery level is above 90%.
- Illuminates green when the tablet is powered on and the battery level is above 15%.

B. Yellow

- Illuminates yellow when the tablet is charging and the battery level is below 90%.

C. Red

- Illuminates red when the tablet is powered on and the battery level is below 15%.

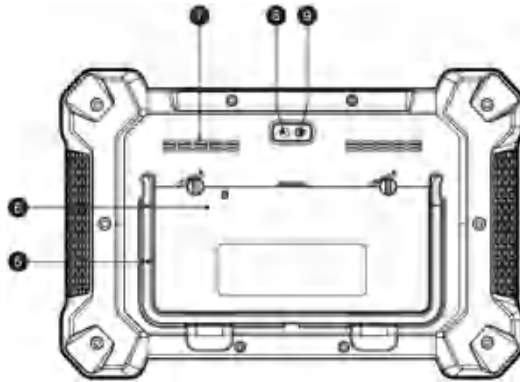

**Figure 2-2 MaxiCOM Tablet, Back View**

- 5. Collapsible Stand — extends from the back to allow hands-free viewing of the tablet.
- 6. Built-in Battery
- 7. Loudspeaker
- 8. Camera
- 9. Camera Flash

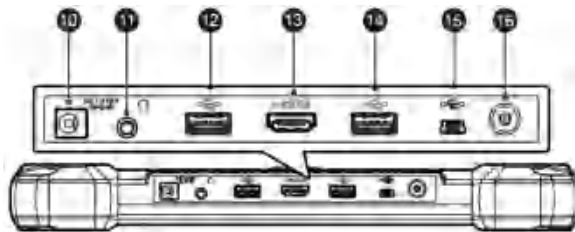

**Figure 2-3 MaxiCOM Tablet, Top View**

- 10. DC Power Supply Input Port
- 11. Headphone Jack
- 12. USB Port
- 13. HDMI (high-definition multimedia interface) Port
- 14. USB Port
- 15. Mini USB Port
- 16. Power/Lock Button — long press to turn the tablet on or off, or short press to lock the screen.

## **Power Sources**

The tablet can receive power from any of the following sources:

- Internal Battery Pack
- AC/DC Power Supply

### *Internal Battery Pack*

The tablet can be powered with the internal rechargeable battery, which if fully charged can provide sufficient power for about 7.5 hours of continuous operation.

### *AC/DC Power Supply*

The tablet can be powered from a wall socket using the AC/DC power adapter. The AC/DC power supply also charges the internal battery pack.

## **! IMPORTANT**

Please charge the battery with the ambient temperature between 0 °C and 45 °C (32 to 113 °F). If charge the battery when the temperature is out of range, the battery may catch on fire.

## **Technical Specifications**

***Table 2-1 Tablet Specifications***

<b>Item</b>	<b>Description</b>
<b>Operating System</b>	Android™ 10
<b>Processor</b>	Qualcomm Longevity Platform: SDM660/SDA660 2.2 GHz Quad high-performance Kryo cores 1.9 GHz Quad low-power Kryo cores
<b>Memory</b>	4 GB RAM & 128 GB On-board Memory
<b>Display</b>	10.1-inch LED capacitive touchscreen with 1920 x 1200 resolution
<b>Connectivity</b>	<ul style="list-style-type: none"> <li>● Wi-Fi (802.11 a/b/g/n/ac)</li> <li>● USB: 2.0</li> <li>● Bluetooth V 5.0 + EDR</li> <li>● SD card (Support up to 64 GB)</li> <li>● HDMI</li> </ul>
<b>Camera (Rear)</b>	<ul style="list-style-type: none"> <li>● 16.0 Megapixel</li> <li>● AF (auto focus) with Flashlight</li> </ul>
<b>Sensors</b>	Gravity Accelerometer, Ambient Light Sensor (ALS)

Item	Description
<b>Audio Input/Output</b>	<ul style="list-style-type: none"> <li>● Microphone</li> <li>● Dual Speakers</li> <li>● 3-Band 3.5 mm stereo/standard headset jack</li> </ul>
<b>Power and Battery</b>	<ul style="list-style-type: none"> <li>● 15000 mAh 3.8 V lithium-polymer battery</li> <li>● Charging via 12 V AC/DC power supply with the temperature between 0 °C and 45 °C (32 to 113 °F)</li> </ul>
<b>Input Voltage</b>	12 V (9-24 V)
<b>Power Consumption</b>	6.5 W
<b>Operating Temp.</b>	0 to 50 °C (32 to 122 °F)
<b>Storage Temp.</b>	-20 to 60 °C (-4 to 140 °F)
<b>Housing</b>	Strong plastic housing with protective rubber boot
<b>Dimensions (W x H x D)</b>	312 mm (12.28") x 208 mm (8.18") x 36 mm (1.41")
<b>Weight</b>	NW: 1.48 kg (3.26 lbs.)
<b>Protocols</b>	ISO 9142-2, ISO 14230-2, ISO 15765-4, K/L-Line, Flashing Code, SAE-J1850 VPW, SAE-J1850 PWM, CAN ISO 11898, Highspeed, Middlespeed, Lowspeed and Singlewire CAN, GM UART, UART Echo Byte Protocol, Honda Diag-H Protocol, TP 2.0, TP 1.6, SAE J1939, SAE J1708, Fault-Tolerant CAN

## VCI — Wireless Diagnostic Interface

### Function Descriptions

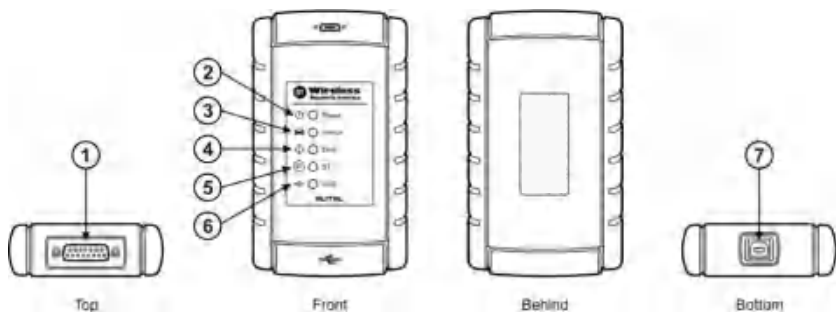

**Figure 2-4 Wireless Diagnostic Interface — for MaxiCOM MK908 II**

1. Vehicle Data Connector (DB15-Pin)
2. Power LED — lights solid green when the device is powered on.

3. Vehicle LED — flashes green when the device is communicating with the vehicle network.
4. Error LED — lights solid red when a serious hardware failure occurs; also flashes red when the device is updating software/firmware.
5. Bluetooth LED — lights solid green when the device is connected with the tablet via Bluetooth communication; also flashes green when the data is being transmitted between the vehicle and the tablet.
6. USB LED — lights solid green when the device is properly connected and communicating with the tablet via the USB cable.
7. USB Port

### *Communication*

The Wireless Diagnostic Interface supports both Bluetooth and USB communication. It can transmit vehicle data to the tablet with or without a physical connection. The working range of the transmitter through Bluetooth communication is about 210 feet (about 70 m). A signal lost due to moving out of range automatically restores itself when the tablet is brought closer to the VCI unit.

## **Power Sources**

The Wireless Diagnostic Interface operates on 12-volt vehicle power, which it receives through the vehicle data connection port. The unit powers on whenever it is connected to an OBDII/EOBD compliant Data Link Connector (DLC).

## **Technical Specifications**

*Table 2-2 Wireless Diagnostic Interface Specifications*

<b>Item</b>	<b>Description</b>
<b>Communications</b>	Bluetooth V 2.1 + EDR; USB 2.0
<b>Wireless Frequency</b>	2.4 GHz
<b>Input Voltage Range</b>	12 VDC
<b>Supply Current</b>	200 mA @ 12 VDC
<b>Operating Temperature</b>	0 °C to 50 °C (32 to 122 °F ambient)
<b>Storage Temperature</b>	-20 °C to 70 °C (-4 to 158 °F ambient)
<b>Dimensions (L x W x H)</b>	147.5 mm (5.80") x 85.5 mm (3.37") x 29.0 mm (1.14")



Item	Description
Weight	0.215 kg (0.473 lb.)

## VCI — J2534 ECU Programming Device

### Function Descriptions

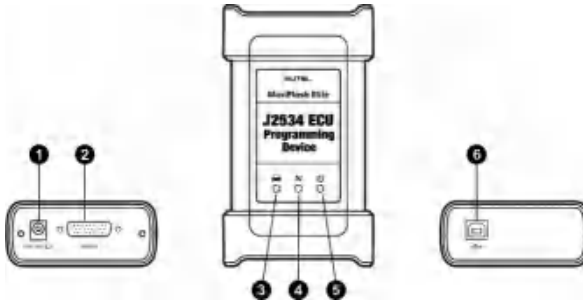

**Figure 2-5 J2534 ECU Programming Device**

1. DC Power Supply Input Port
2. Vehicle Data Connector (DB26-Pin)
3. Vehicle LED — flashes green when the device is communicating with the vehicle's system.

#### **!** IMPORTANT

Do not disconnect the J2534 ECU programming device while this vehicle LED is on! If the flash reprogramming procedure is interrupted while the vehicle's ECU is blank or only partially programmed, the module may be unrecoverable.

4. Connection LED — lights solid green when the device is properly connected with the tablet via the USB cable or lights solid blue via wireless Bluetooth connection.
5. Power LED — lights solid green when the device is powered on.
6. USB Port

#### *J2534 Reprogramming Capability*

The J2534 ECU Programming Device is a SAE J2534-1 & -2 compliant PassThru reprogramming interface device. Using the updated OEM software, it is capable of replacing the existing software/firmware in the Electronic Control Units (ECU), programming new ECUs and fixing software-controlled drivability issues and emission issues.

## Communication

The J2534 ECU programming device supports Bluetooth and USB communications. It can transmit vehicle data to the MaxiCOM tablet with or without a physical connection. The working range of the transmitter through Bluetooth communication is 210 feet (about 70 m). A signal lost due to moving out of range automatically restores itself when the tablet unit is brought closer to the VCI unit.

## Power Sources

The J2534 programming device can receive power from both of the following sources:

- Vehicle Power
- AC/DC Power Supply

### *Vehicle Power*

The J2534 programming device operates on 12-volt vehicle power, which it receives through the vehicle data connection port. The device powers on whenever it is connected to an OBDII/EOBD compliant Data Link Connector (DLC). For non OBDII/EOBD compliant vehicles, the device can be powered from auxiliary power outlet or other suitable power port on the test vehicle using the auxiliary power cable.

### *AC/DC Power Supply*

The J2534 programming device can be powered from a wall socket using the AC/DC power adapter.

## Technical Specifications

**Table 2-3 J2534 ECU Programming Device Specifications**

Item	Description
<b>Communications</b>	Wireless Bluetooth V 2.1 + EDR; USB 2.0
<b>Wireless Frequency</b>	2.4 GHz
<b>Input Voltage Range</b>	12 VDC to 24 VDC
<b>Supply Current</b>	170 mA @ 12 VDC 100 mA @ 24 VDC
<b>Operating Temp.</b>	0 °C to +60 °C (32 to 140 °F ambient)
<b>Storage Temp.</b>	-65 °C to +100 °C (-85 to 212 °F ambient)

Item	Description
Dimensions (L x W x H)	149 mm (5.87") x 86 mm (3.38") x 35 mm (1.28")
Weight	0.29 kg (0.64 lb.)

## Accessories Kit

---

### Main Cable

The VCI can be powered through the Main Cable when connected to an OBDII/EOBD compliant vehicle. The Main Cable connects the VCI to the vehicle's Data Link Connector (DLC), through which the VCI can transmit vehicle data to the tablet.



*Figure 2-6 Main Cable — 1.5 m in Length*

### OBDI Adapters (Optional)

The optional OBDI adapters are for Non-OBDII vehicles. The adapter used depends on the type of vehicle being tested. The most common adapters are shown.



Suitable for  
Benz-14



Suitable for  
Chrysler-16



Suitable for  
BMW-20



Suitable for Kia-  
20



Suitable for  
Nissan-14



Suitable for  
GM/Daewoo-12



Suitable for  
Honda-3



Suitable for Fiat-3



Suitable for  
PSA-2



Suitable for  
Benz-38



Suitable for  
Volkswagen/Au-  
di-2+2



Suitable for  
Mitsubishi/Hyun-  
dai-12+16

## Other Accessories

	<p><b>Standard 2.0 USB Cable</b> Connects the tablet to the VCI.</p>
	<p><b>Mini USB Cable</b> Connects the tablet to the Windows-based PC.</p>
	<p><b>AC/DC External Power Adapter</b> Connects the tablet to the external DC power port for power supply.</p>
	<p><b>Ethernet Serial Cable</b> Connects the tablet to the VCI unit (for MaxiCOM MK908Pro II only).</p>
	<p><b>Auxiliary Power Outlet Adapter</b> Provides power to the tablet or the J2534 programming device through connection to the vehicle's auxiliary power outlet, as some non-OBDII vehicles cannot provide power via the DLC connection.</p>
	<p><b>Clamp Cable</b> Provides power to the tablet or the J2534 programming device, through connection to the vehicle's battery (for MaxiCOM MK908Pro II only).</p>
	<p><b>Spare Fuse x2</b> A safety device for the auxiliary power outlet adapter.</p>
	<p><b>BMW Ethernet Cable (Optional)</b> Used for BMW F/G chassis programming and coding.</p>



### **USB to Ethernet Adapter**

Network connection function can be realized through this device.

# 3. Getting Started

Make sure the tablet is fully charged or is connected to an external power supply (see [Power Sources](#) for details).

## Powering Up

---

Long press the **Power/Lock** button on the top right side of the tablet to switch the unit on. The system boots up and shows the lock screen. Press and swipe upward to unlock the screen and the MaxiCOM Job Menu is shown.



**Figure 3-1 MaxiCOM Job Menu**

1. Application Buttons
2. Page Control and Navigation Buttons
3. System Status Icons

---

### NOTE

The screen is locked by default upon startup. It is recommended to lock the screen to protect information in the system and conserve power.











---







Almost all operations on the tablet are controlled through the touch screen. The touch screen navigation is menu-driven, which allows you to quickly locate the test procedure or data that you need, through a series of choices and questions. Detailed descriptions of the menu items are found in the chapters for the various applications.

# Application Buttons

The Application buttons configure the MaxiCOM for the type of operation or activity to be performed. The table below gives brief descriptions of the available applications.

**Table 3-1 Applications**





Name	Button	Description
<b>Diagnostics</b>		Accesses the unit's diagnostics functions. See <a href="#">Diagnostics</a> for details.
<b>Data Manager</b>		Accesses the saved repair shop, customer and vehicle data including detailed vehicle diagnostics and test records. See <a href="#">Data Manager</a> for details.
<b>Battery Test</b>		Accesses the Battery Test menu with two functions, including in-vehicle test and out-vehicle test. See <a href="#">Battery Test</a> for details.
<b>User Feedback</b>		Allows you to submit problem feedbacks related to this tablet. See <a href="#">User Feedback</a> for details.
<b>Settings</b>		Allows you to set the MaxiCOM system settings and view the general information about the tablet. See <a href="#">Settings</a> for details.
<b>Update</b>		Accesses system software update menu. See <a href="#">Update</a> for details.
<b>VCI Manager</b>		Accesses VCI connection menu. See <a href="#">VCI Manager</a> for details.
<b>Remote Desktop</b>		Configures your unit to receive remote support using the TeamViewer application. See <a href="#">Remote Desktop</a> for details.
<b>Support</b>		Launches the Support platform that synchronizes Autel's online service base station with the MaxiCOM tablet. See <a href="#">Support</a> for details.
<b>Quick Link</b>		Provides associated website bookmarks to allow quick access to product update, service, support, and other information. See <a href="#">Quick Link</a> for details.

Name	Button	Description
<b>MaxiScope</b>		Configures the unit to operate as an automotive oscilloscope to perform electrical and electronic circuit tests and monitor signal activities. See <a href="#">MaxiScope</a> for details.
<b>MaxiViewer</b>		Provides a quick search for supported functions and/or vehicles. See <a href="#">MaxiViewer</a> for details.
<b>MaxiVideo</b>		Configures the unit to operate as a video scope device by connecting to an imager head cable for close vehicle inspections. See <a href="#">MaxiVideo</a> for details.
<b>OEM Authorization</b>		Accesses OEM Authorization menu. See <a href="#">OEM Authorization</a> for details.
<b>Service</b>		Accesses special functions menu. See <a href="#">Service</a> for details.
<b>Autel User Center</b>		Allows you to register an account, view, and edit your personal profile and link your device.







## Page Control and Navigation Buttons

Operations of the page control and navigation buttons are described as below:

**Table 3-2 Page Control and Navigation Buttons**

Name	Button	Description
<b>Page Control</b>		Indicates the location of the current screen. Swipe the screen to left or right to view the previous or next screen.
<b>Back</b>		Returns to the previous screen.
<b>MaxiCOM Home</b>		Returns to the MaxiCOM Job Menu.
<b>Android Home</b>		Returns to the Android System Home screen.

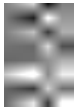

Name	Button	Description
<b>Recent Apps</b>		Displays a list of applications that are currently working. Select an application to open it. To remove an app, swipe it to the right or the left side.
<b>Browser</b>		Launches the Google Chrome browser.
<b>Camera</b>		<ul style="list-style-type: none"> <li>• Tap to launch camera.</li> <li>• Press and hold to capture a screenshot of the display screen.</li> </ul> Saved files are stored in the Data Manager application for later review. See <a href="#">Data Manager</a> for details.
<b>Display &amp; Sound</b>		Allows you to adjust the brightness of the screen and the volume of the audio output.
<b>VCI</b>		Opens the VCI Manager application. A green Bluetooth or USB cable icon at the bottom-right corner indicates the VCI is connected via Bluetooth or USB cable, while a red “x” indicates no connection.
<b>Diagnostics Shortcut</b>		Returns to the Diagnostics screen.
<b>Service Shortcut</b>		Returns to the Service screen.

➤ **To use the camera**

1. Tap the **Camera** button. The camera screen opens.
2. Focus the image to be captured in the viewfinder.
3. Tap the Camera icon on the right of the screen. The viewfinder now shows the captured picture and auto-saves the taken photo.
4. Tap the thumbnail image on the top-right corner of the screen to view the stored image.
5. Tap the **Back** or **Home** button to exit the camera application.

## System Status Icons

These are the standard status icons of the Android operating system. Your MaxiCOM tablet is a fully functional Android Tablet.

## Powering Down

---

All vehicle communications must be terminated before shutting down the tablet. A warning message displays if you attempt to shut down while the VCI unit is communicating with the vehicle. Forcing a shut down while the tablet is communicating may lead to ECU (Electronic Control Units) problems on some vehicles. Please fully exit the Diagnostics application before shutting off the tablet.

➤ **To power down the MaxiCOM tablet**

1. Long press the **Power/Lock** button.
2. Tap **Power Off**.
3. Tap **OK**.

## Reboot System

In case of a system crash, press and hold the **Power/Lock** button and tap **Restart** to restart the system.

---

 **NOTE**

The MaxiSys Printer runs automatically after the installation.

---

## Printing

---

This section describes how to receive files from the MaxiCOM tablet and perform printing through the computer:

➤ **To perform printing through the computer**

1. Install the MaxiSys Printer driver to the computer.
2. Make sure the tablet is connected to the computer network, either via Wi-Fi or LAN, before printing. See [Printing Settings](#) for more information.
3. Run the **PC Link** program on the computer to open up the printer interface.
4. Click **Test Print** to make sure the printer is working successfully.
5. Tap the **Print** button on the toolbar displayed in various applications of the MaxiCOM system. A temporary file will be created and sent to the computer for printing.

6. The MaxiSys Printer will print the received file automatically when the Auto Print option is checked.

If you need to print the document later, click **Open PDF file** and select the document, and double click **Print** on the MaxiSys Printer interface to start the printing.

---

 **NOTE**

Make sure the computer installed with the Printing Services program is connected to a printer.

---

## Installing Computer Software

The MaxiCOM MK908 II/MaxiCOM MK908Pro II Diagnostic Platform allows you to realize some of its functions on a computer to enhance capabilities and improve user experience. To realize these functions on a computer, you need to install certain software.

### ➤ To install the MaxiSys Printer driver program

1. Download Maxi PC Suite on [www.autel.com](http://www.autel.com) > Support > Downloads > Autel Update Tools. Select **Maxi PC Suite** and click **Download here** to install the printer to your PC.
2. Double click the **setup.exe** file.
3. Select the installation language and the wizard will load momentarily.
4. Follow the instructions on the screen and click **Next** to continue.
5. Click **Install**. The printer driver program will be installed to the PC.
6. Click **Finish** to complete the installation.

# 4. Diagnostics

The Diagnostics application can access the Electronic Control Module (ECM) for various vehicle control systems, such as engine, transmission, Antilock Brake System (ABS), Airbag System (SRS) and more.

## Establishing Vehicle Communication

---

The Diagnostics operations require connecting the MaxiCOM MK908 II&MaxiCOM MK908Pro II Diagnostics Platform to the test vehicle through the VCI using the main cable or test adapters (for non-OBDII vehicles). To establish proper vehicle communication to the tablet, you need to perform the following steps:

1. Connect the VCI to the vehicle's DLC for both communication and power source.
2. Connect the VCI to the tablet via Bluetooth pairing or USB connection.
3. When the above steps are completed, check the VCI navigation button at the bottom bar on the screen, if a green badge displays at the lower-right corner, the MaxiCOM MK908 II&MaxiCOM MK908Pro II diagnostic platform is ready to start vehicle diagnosis.

### Vehicle Connection

The method used to connect the VCI to a vehicle's DLC depends on the vehicle's configuration as follows:

- A vehicle equipped with an On-board Diagnostics Two (OBDII) management system supplies both communication and 12-volt power through a standardized J-1962 DLC.
- A vehicle not equipped with an OBDII management system supplies communication through a DLC connection, and in some cases supplies 12-volt power through the auxiliary power outlet or other connection to the vehicle battery.

#### *OBDII Vehicle Connection*

This type of connection only requires the main cable without any additional adapter.

➤ **To connect to an OBDII vehicle**

1. Connect the main cable's female adapter to the Vehicle Data Connector on the VCI, and tighten the captive screws.
2. Connect the cable's male adapter to the vehicle's DLC, which is generally located under the vehicle dashboard.

---

 **NOTE**

The vehicle's DLC is not always located under the dashboard. Refer to the user manual of the test vehicle for additional connection information.

---

*Non-OBDII Vehicle Connection*

This type of connection requires both the main cable and a required OBDI adapter for the specific vehicle being serviced.

There are three possible conditions for non-OBDII vehicle connection:

- DLC connection supplies both communications and power.
- DLC connection supplies communications and power via the vehicle's auxiliary power outlet.
- DLC connection supplies communications and power via connection to the vehicle battery.

➤ **To connect to a non-OBDII Vehicle**

1. Connect the main cable's female adapter to the vehicle data connector on the VCI, and tighten the captive screws.
2. Locate the required OBDI adapter and connect its jack to the main cable's male adapter.
3. Connect the attached OBDI adapter to the vehicle's DLC.

---

 **NOTE**

Some vehicles may have more than one adapters or may have test leads instead of an adapter. Whatever the case, make the proper connection to the vehicle's DLC as required.

---

- **To connect the auxiliary power outlet adapter**
  1. Plug the DC power connector of the auxiliary power outlet adapter into the DC power supply input port on the device.
  2. Connect the male connector of the auxiliary power outlet adapter into the vehicle's auxiliary power outlet.
- **To connect the clamp cable (*MaxiCOM MK908Pro II only*)**
  1. Connect the tubular plug of the clamp cable to the male connector of the auxiliary power outlet.

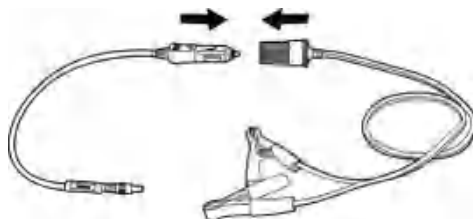

**Figure 4-1 Connection between the Auxiliary Power Outlet and Clamp Cable**

2. Plug the DC power connector of the auxiliary power outlet adapter into the DC power supply input port of the J2534 programming device.
3. Connect the clamp cable to the vehicle battery.

#### **NOTE**

After the VCI is successfully connected to the vehicle, the Power LED on the device will illuminate and a brief beep will sound.

## **VCI Connection**

After the VCI is properly connected to the vehicle, the Power LED on the VCI will illuminate solid green indicating that the device is ready to establish communication with the tablet.

The Wireless Diagnostic Interface (included with the MaxiCOM MK908 II tool kit) supports two communication methods with the MaxiCOM tablet: Bluetooth and USB.

The J2534 ECU Programming Device (included with the MaxiCOM MK908Pro II tool kit) supports two communications methods with the MaxiCOM tablet: Bluetooth and USB.

### ***Bluetooth Connection***

Bluetooth (BT) pairing is recommended as the first choice for the communication between the tablet and the VCI. The working range for Bluetooth communication is about

210 feet (70 m); this means you can perform vehicle diagnosis freely around the workshop with greater convenience.

To expedite multi-vehicle diagnostics, more than one VCI can be used in busy repair shops, enabling technicians to quickly pair (via Bluetooth) their diagnostic tablets to each VCI separately and therefore eliminating the need to physically connect the VCI to each vehicle.

➤ **To pair up the tablet with the VCI via Bluetooth**

1. Power up the tablet.
2. Select the **VCI Manager** application from the MaxiCOM Job Menu.
3. When the **VCI Manager** application is opened, the device automatically starts scanning for available VCI around for Bluetooth pairing. Available VCIs are listed in the Setting section on the right side of the screen.

---

 **NOTE**

If no VCI is found, this may indicate that the signal strength of the transmitter is too weak to be detected. In this case try to get closer to the device, or reposition the VCI, and remove all possible objects that may cause signal interference. When these are done, tap the **Scan** button at the top-right corner to start searching again.

---

4. The VCI name appears as “Maxi” suffixed with the device serial number. Select the required device for pairing. (If more than one VCIs are used in the shop, ensure the correct VCI is selected to pair.)
5. When pairing is successfully done, the connection status displayed to the right of the device name reads “Connected.”
6. Wait for a few seconds, and the VCI button on the system Navigation bar at the bottom of the screen shall display a green **Bluetooth** icon, indicating the tablet is connected to the VCI, and is ready to perform vehicle diagnosis.

Refer to [VCI Bluetooth Pairing](#) for additional information.

### *USB Cable Connection*

The USB cable connection is a simple way to establish communication between the tablet and VCI. After properly connecting the USB cable from the tablet to the VCI, the VCI navigation button at the bottom bar of the screen shows a green **USB** icon in a few seconds, and the USB LED on the VCI will illuminate solid green, indicating the connection between the devices is successful.

The MaxiCOM diagnostic platform is now ready to perform vehicle diagnosis.

---

 **NOTE**

Since the USB connection provides the most stable and fastest communication, it is highly recommended to apply this communication method when operating ECU programming or coding. When all the two communication methods are applied at the same time, the MaxiCOM system will use the USB communication as the default priority.

---

## No Communication Message

- A. If the tablet is not connected to the VCI, an error message will appear. An error message indicates the tablet is not communicating with the VCI, and so cannot gain access to the vehicle control module. In this case, you need to perform the following check-ups:
- Check that the VCI is powered on.
  - In case of wireless connection, check that the network is configured correctly, and that the right device has been paired.
  - If during the diagnosis process communication is suddenly interrupted due to the loss of signal, check that there are no objects causing signal interference.
  - Check that the VCI is properly positioned. It is recommended to position the VCI with its front-side up.
  - Try standing closer to the VCI to obtain a more stable signal and faster communication speed. In case of a wired connection, check the cable connection between the tablet and the VCI.
  - Check that the LED on the VCI is illuminated green for Bluetooth or USB.
  - Check that the Error LED on the VCI is on, this may indicate a communication error between the devices. In this case try re-establishing the connection again; if this does not work, there may be a hardware problem with the device. Please contact Autel or local distributor for further technical support.
- B. If the VCI is unable to establish a communication link, a prompt message will display with further instructions. The following conditions are possible causes for this message to display:
- The VCI is unable to establish a communication link with the vehicle.
  - You have selected a system for testing that the vehicle does not support.
  - There is a loose connection.
  - There is a blown vehicle fuse.
  - There is a wiring fault on the vehicle, data cable or adapter.
  - There is a circuit fault in the data cable or adapter.
  - The wrong vehicle has been identified; check the VIN.



# Getting Started

Prior to first use of the Diagnostics application, the VCI must be synchronized with the tablet to establish a communication link. See [VCI Manager](#) for details.

## Vehicle Menu Layout

When the VCI is properly connected to the vehicle and paired to the tablet, the platform is ready to start vehicle diagnosis. Tap on the **Diagnostics** application button on the MaxiCOM Job Menu, the screen then opens the Vehicle Menu.





**Figure 4-2 Vehicle Menu Screen**









1. Top Toolbar Buttons
2. Automobile Manufacturer Buttons

### Top toolbar Buttons

The operations of the Toolbar buttons at the top of the screen are listed and described in the table below:

**Table 4-1 Top Toolbar Buttons**

Name	Button	Description
Home		Returns to the MaxiCOM Job Menu.
VID Scan		Opens a drop-down list: <ul style="list-style-type: none"><li>• Tap <b>Auto Detect</b> for auto VIN detection.</li><li>• Tap <b>Manual Input</b> to enter VIN manually.</li><li>• Tap <b>Scan VIN/License</b> to scan the VIN/license number by camera.</li></ul>

Name	Button	Description
<b>All</b>		Displays all the vehicle makes in the vehicle menu.
<b>Favorites</b>		Displays user-favorited vehicle makes.
<b>History</b>		Displays stored test vehicle records. This option provides direct access to the previously tested vehicle recorded during previous test sessions. For details, see <a href="#">Vehicle History</a> .
<b>America</b>		Displays the American vehicle menu.
<b>Europe</b>		Displays the European vehicle menu.
<b>Asia</b>		Displays the Asian vehicle menu.
<b>China</b>		Displays the Chinese vehicle menu.
<b>Search</b>		Displays the search field. Tap the field to open the virtual keyboard and enter a vehicle manufacturer to test.
<b>Cancel</b>		Exits the search screen or cancel an operation.

### *Manufacturer Buttons*

The Manufacturer buttons display various vehicle logos and the brand names. Select the required manufacturer button after the VCI is properly connected to the test vehicle to start a diagnostic session.

## **Vehicle Identification**

---

The MaxiCOM diagnostics system supports five methods for vehicle identification.

1. Auto VIN Scan
2. Manual VIN Input
3. Scan VIN/License
4. Manual Vehicle Selection
5. OBD Direct Entry

# Auto VIN Scan

The MaxiCOM diagnostic system features the latest VIN-based Auto VIN Scan function to identify vehicles with just one tap, which allows the technician to quickly detect vehicles, scan all the diagnosable ECUs on every vehicle, and run diagnostics on the selected system.

➤ **To perform Auto VIN Scan**

1. Tap the **Diagnostics** application button from the MaxiCOM Job Menu. The Vehicle Menu displays.
2. Tap the **VID Scan** button on the top toolbar.
3. Select **Auto Detect**. The tester starts VIN scanning on the vehicle's ECU. Once the test vehicle is successfully identified, the system will guide you to the Vehicle Diagnostics screen directly.

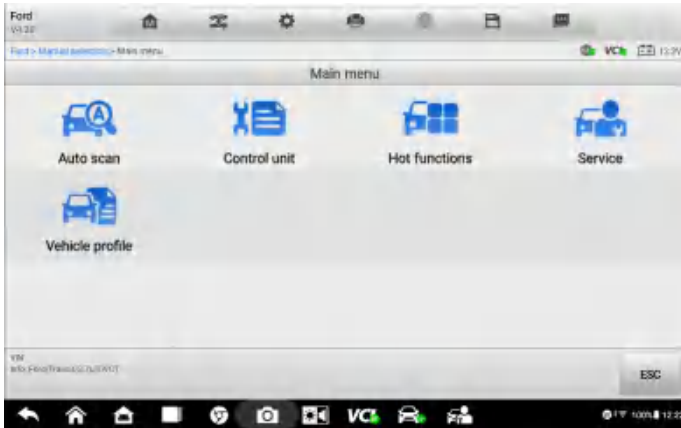

**Figure 4-3 Vehicle Diagnostics Screen**

In some cases, the Auto VIN function is still available for some vehicle makes after being selected.

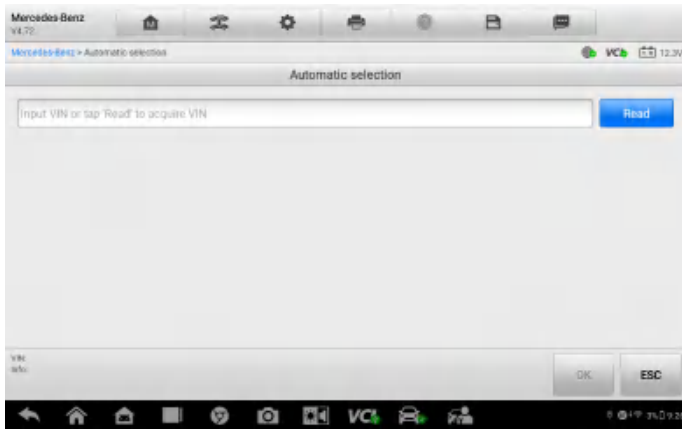

**Figure 4-4 Vehicle Selection Screen**

Select **Automatic Selection** and the system will proceed to acquire VIN information automatically or allow users to input the VIN manually.

## Manual VIN Input

For some vehicles that do not support the Auto VIN Scan function, the MaxiCOM diagnostic system allows you to enter the vehicle VIN manually, or simply take a photo of the VIN sticker for quick vehicle identification.

### ➤ To perform Manual VIN Input

1. Tap the **Diagnostics** application button from the MaxiCOM Job Menu. The Vehicle Menu displays.
2. Tap the **VID Scan** button on the top toolbar.
3. Select **Manual Input**.
4. Tap the input box and enter the correct VIN or license number.

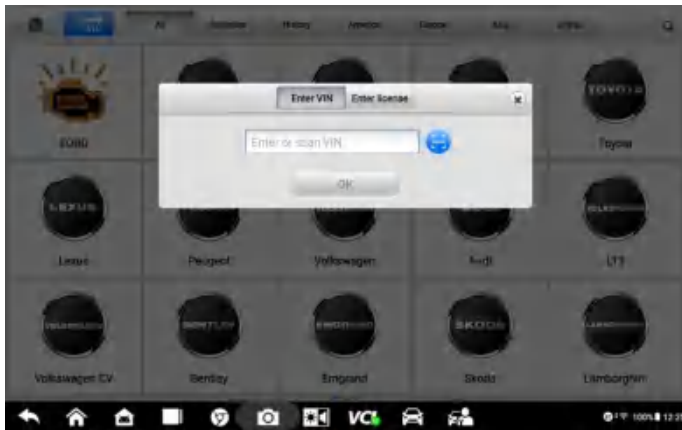

**Figure 4-5 Manual VIN Input**

5. Tap **OK**. The vehicle will be identified in a few seconds, and once the matching is successful, the system will guide you to the Vehicle Diagnostics screen directly.
6. Tap “**x**” to exit Manual Input.

## Scan VIN/License

Tap **Scan VIN/License** in the drop-down list. The camera app will launch. On the right side of the screen, three options are available: **Scan QR Code/Barcode**, **Scan VIN**, and **Scan License**.

---

### **NOTE**

The Scan License option is supported in certain countries and areas. If not available, manually enter the license number.

---

Select one of three options and position the tablet to align the VIN or license number within the scanning window, the result appears in the Recognition result dialog box after scanned. Tap **OK** to confirm the result, and then the vehicle information confirmation screen will appear on the tablet. If all the vehicle information is correct, tap the icon on the middle of the screen to confirm the VIN of the test vehicle. Tap **OK** to continue.

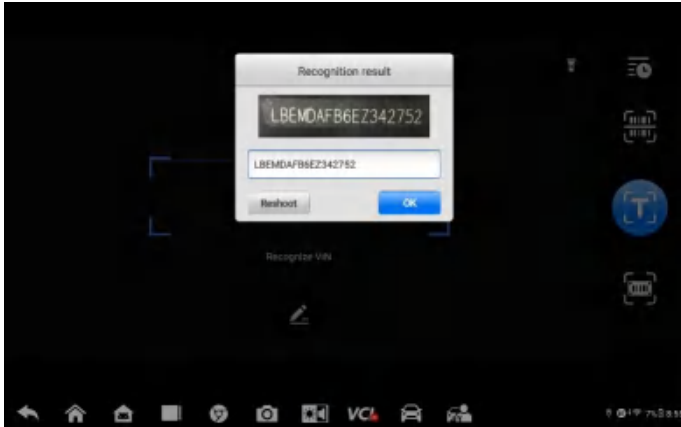

**Figure 4-6a Scan VIN Code 1**

If the VIN/License number cannot be scanned, manually enter it after tapping the pen-shape  icon. Tap **OK** to continue. Manually enter the license number and select a vehicle brand in the vehicle information confirmation screen. Tap the icon on the middle of the screen to confirm the VIN of the test vehicle. Tap **OK** to continue.

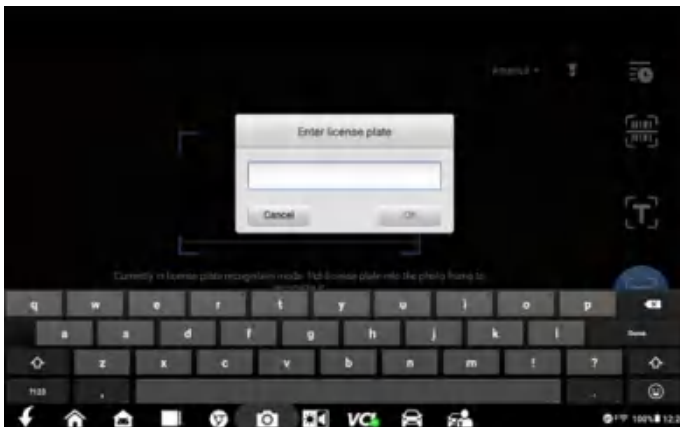

**Figure 4-6b Scan VIN Code 2**

## Manual Vehicle Selection

When the vehicle's VIN is not automatically retrievable through the vehicle's ECU, or when the specific VIN is unknown, you can choose to select the vehicle manually.

### *Step-by-step Vehicle Selection*

This mode of vehicle selection is menu driven. Select the Vehicle Makes icon on the Vehicle Menu screen and the "Select Diagnostic Type" screen appears. Then tap the **Manual selection** button. Select the vehicle information (e.g., the brand, model, capacity, engine type, and model year) on the same screen. Tap the **Reset** button to reselect the vehicle information, if needed. The **ESC** button at the lower-right corner of the screen will bring you back to the previous screen.

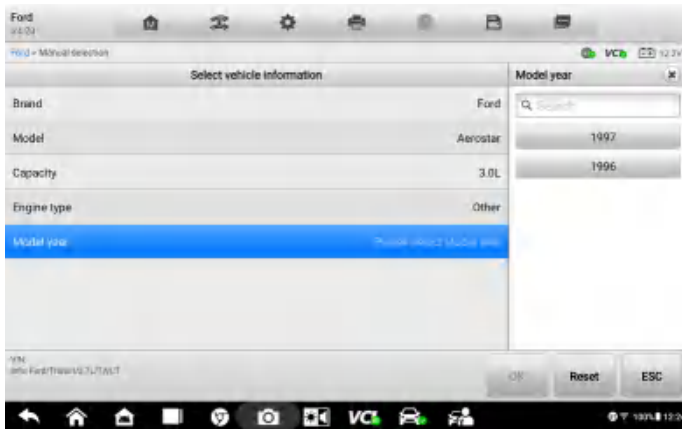

**Figure 4-7 Manual Vehicle Selection Screen**

## Alternative Vehicle Identification

Occasionally, you may identify a test vehicle that the tester does not recognize; the database does not support, or has some unique characteristics that prevent it from communicating with the tester through normal channels. In these instances, you are provided with the OBD direct entry, through which you can perform generic OBDII or EOBD tests. See [Generic OBDII Operations](#) for additional information.

## Navigation

---

This section describes how to navigate the Diagnostics interface and select test options.

### Diagnostics Screen Layout

The Diagnostics screens typically include five sections.

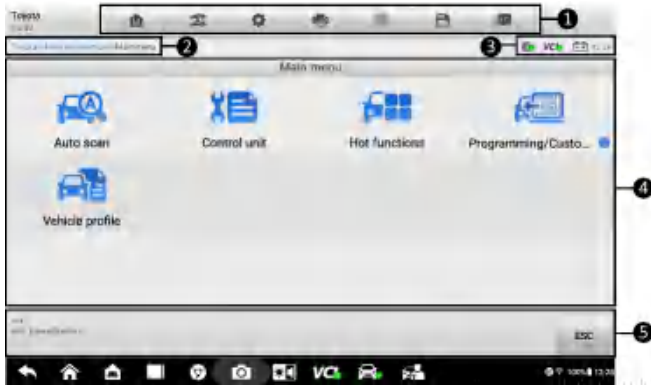





**Figure 4-8 Diagnostics Screen**

1. Diagnostics Toolbar
2. Current Directory Path
3. Status Information Bar
4. Main Section
5. Function Buttons



### *Diagnostics Toolbar*

The Diagnostics Toolbar contains a number of buttons that allow you to print or save the displayed data and make other controls. The table below provides a brief description for the operations of the Diagnostics toolbar buttons:

**Table 4-2 Diagnostics Toolbar Buttons**

Name	Button	Description
<b>Home</b>		Returns to the MaxiCOM Job Menu.
<b>Vehicle Swap</b>		Exits the diagnostic session and returns to the vehicle menu screen to select another vehicle for testing.
<b>Settings</b>		Opens the settings screen. See <a href="#">Settings</a> for details.
<b>Print</b>		Saves and prints a copy of the displayed data. See <a href="#">Printing Settings</a> for details.
<b>Help</b>		Provides instructions or tips for operations of various diagnostic functions.



Name	Button	Description
<b>Save</b>		Opens a submenu to take a screenshot. All saved data are stored in the Data Manager application for later review. See <a href="#">Data Manager</a> for details.
<b>Data Logging</b>		Tap to display the error options. Select a specific abnormal type, and a submission form will appear to let you enter the report information.

➤ **To print data in Diagnostics**

1. Tap the **Diagnostics** application button from the MaxiCOM Job Menu. The **Print** button on the diagnostic toolbar is available throughout the Diagnostics operations.
2. Tap **Print** and a drop-down menu will appear. Tap **Print this page** to print the current screen.
3. A temporary file will be created and sent to the computer for printing.
4. When the file is transferred successfully, a confirmation message will appear.

 **NOTE**

Make sure the tablet is connected to the computer network (either via Wi-Fi or LAN) before printing. For more instructions on printing, see [Printing](#) for details.

➤ **To submit Data Logging reports in Diagnostics**

1. Tap the **Diagnostics** application button from the MaxiCOM Job Menu. The **Data Logging** button on the diagnostics toolbar is available throughout the Diagnostics operations.
2. Tap the **Data Logging** button to display the error options. Select a specific error, and a submission form will appear to let you enter the report information.
3. Tap the **Send** button in the upper-right corner of the screen to submit the report via the Internet. A confirmation message appears when sent successfully.

*Status Information Bar*

The Status Information Bar at the top of the Main Section displays the following items:

1. Cloud Server Icon — indicates the communication status between the tablet and the Autel Cloud Server.
2. VCI Icon — indicates the communication status between the tablet and the VCI.
3. Battery Icon — indicates the battery status of the vehicle.

## *Main Section*

The Main Section of the screen varies depending on the stage of operations. The Main Section can show vehicle identification selections, the main menu, test data, messages, instructions, and other diagnostic information.

## *Function Buttons*

The displayed function buttons at this section of the screen vary depending on the stage of operations. They can be used to navigate, save or clear the diagnostic data, exit scanning as well as make other functional controls. The functions of these buttons will be introduced in the following sections of the corresponding test operations.

## **Screen Messages**

Screen messages appear when additional input is needed before proceeding. There are mainly three types of on-screen messages as to their purposes: Confirmation, Warning, and Error.

### *Confirmation Messages*

This type of messages usually displays as an “Information” screen, which informs you when you are about to perform an action that cannot be reversed or when an action has been initiated and your confirmation is needed to continue.

When a user-response is not required to continue, the message will display only briefly.

### *Warning Messages*

This type of message informs you when completing the selected action may result in an irreversible change or loss of data. An example of this is the “Erase Codes” message.

### *Error Messages*

Error messages inform you when a system or procedural error has occurred. Examples of possible errors include a disconnected cable or communication interruption.

### *Making Selections*

The Diagnostics application is a menu-driven program that presents a series of choices one at a time. As you make selections in a menu, the next menu in the series appears. Each selection narrows the focus and leads to the desired test. Use your fingertip or the stylus pen to make your selections.

# Main Menu

---

The Diagnostics application allows you to establish a data link to the electronic control system of the test vehicle via the VCI for vehicle diagnosis, service or programming. You can operate functional tests, retrieve vehicle diagnostic information such as trouble codes, event codes and live data, and perform ECU reprogramming, for various vehicle control systems, such as engine, transmission, ABS, and more.

The Vehicle Diagnostics screen has three main options:

1. Diagnosis — a comprehensive section which includes all available functions: reading, clearing, saving and printing diagnostic information, as well as performing active tests and special functions
2. Service — a separate section designed to perform vehicle scheduled service and maintenance, such as to reset the service lights and perform calibration for various systems
3. Programming/Coding — a separate section designed for quick access to ECU reprogramming operations

After a section is selected and the tablet establishes communication with the vehicle via the VCI, the corresponding function menu or selection menu displays.

# Diagnosis

---

There are two options available when accessing the Diagnosis section:

1. Auto Scan — starts auto scanning for all the available systems on the vehicle
2. Control Unit — displays a selection menu of all available control units of the test vehicle

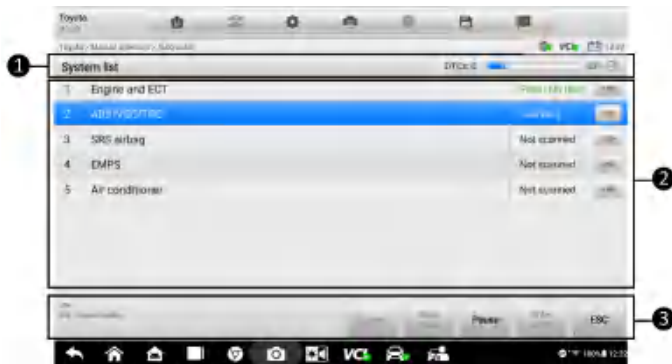

**Figure 4-9 Auto Scan Operation Screen**

# Auto Scan

The Auto Scan function performs a comprehensive scanning over all systems on the vehicle's ECU in order to locate fault systems and retrieve DTCs. The sample operation interface of Auto Scan displays as above:

- ① Navigation Bar
- ② Main Section
- ③ Function Buttons
  - Navigation Bar
    1. List Tab — displays the scanned data in list format
    2. Progress Bar — indicates the test progress
  - Main Section
    - A. List Tab
      - Column 1 — displays the system numbers
      - Column 2 — displays the scanned systems
      - Column 3 — displays the diagnostic marks indicating different conditions of the test result:
        - !-: Indicates that the scanned system may not support the code reading function, or there is a communication error between the tester and the control system.
        - ?-: Indicates that the vehicle control system has been detected, but the tester cannot accurately locate it.
  - Fault | #:** Indicates there is/are fault code(s) present; “#” indicates the number of the detected faults.
  - Pass | No Fault:** Indicates the system has passed the scanning process and no fault has been detected.
  - Not Scanned:** Indicates the system has not been scanned.
  - No Response:** Indicates the system has not received a response.
    - Column 4 — performs further diagnosis and other test activities. A Function Menu screen shall display when you tap the  button.
  - Function Buttons

The table below provides a brief description of the function buttons' operations in Auto Scan:

**Table 4-3 Function Buttons in Auto Scan**

Name	Description
<b>Report</b>	Displays the diagnostics data in the report form.
<b>Quick Erase</b>	Deletes codes. A warning message will appear to inform you of possible data loss when this function is selected.
<b>Pause</b>	Suspends scanning and changes to the <b>Continue</b> button.
<b>Enter System</b>	Enters the ECU system.
<b>ESC</b>	Returns to the previous screen or exits Auto Scan.

## Control Unit

This option allows you to manually locate a required control system for testing. Simply follow the menu-driven procedure and the program will guide you to the diagnostic function menu.

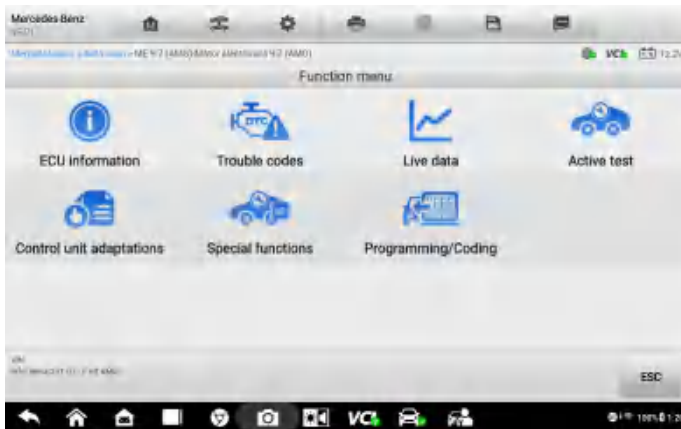

**Figure 4-10 Function Menu Screen**

The Function Menu options vary slightly for different vehicles. The function menu may include:

- ECU Information — provides the retrieved ECU information in detail. Selecting it opens an information screen.

- **Trouble Codes** — contains Read Codes and Erase Codes. The former displays detailed DTC information retrieved from the vehicle control module, the latter facilitates you to erase DTCs and other data from the ECU.
- **Live Data** — retrieves and displays live data and parameters from the vehicle's ECU.
- **Active Test** — provides specific subsystem and component tests. This selection may appear as Actuators, Actuator Test or Function Tests, etc. And the test options vary depending on the vehicle manufacturer and model.
- **Special Functions** — provides component adaptation or variant coding functions for custom configurations, and also allows you to reprogram adaptive values for certain components after making repairs. Depending on the test vehicle, this selection may sometimes appear as Control Unit Adaptations, Variant Coding, Configuration or something similar.

---

 **NOTE**

With the diagnostic toolbar on top of the screen throughout the whole diagnostic procedures, you are allowed to make various controls of the diagnostic information at anytime, such as printing and saving the displayed data, getting help information, or performing data logging.

---

➤ **To perform a diagnostic function**

1. Establish communication with the test vehicle via the VCI.
2. Identify the test vehicle by selecting from the menu options.
3. Locate the required system for testing by **Auto Scan** or through menu driven selections in **Control Unit**.
4. Select the desired test from the Function Menu screen.

## **ECU Information**

This function retrieves and displays the specific information for the tested control unit, including unit type, version numbers, and other specifications.

The sample ECU Information screen displays as below:

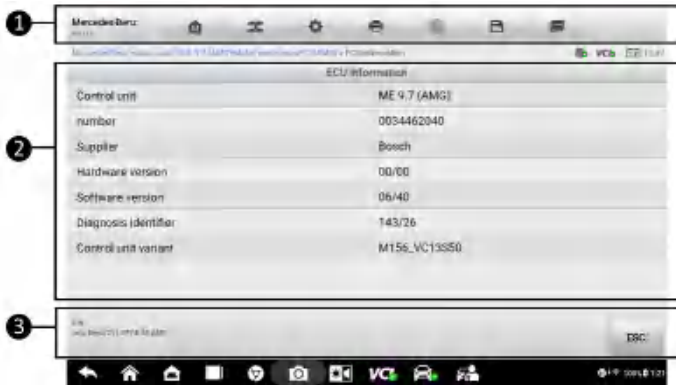
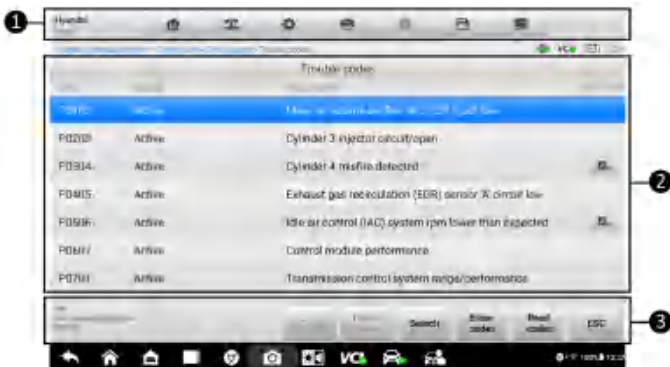

**Figure 4-11 ECU Information Screen**

1. **Diagnostics Toolbar Buttons** — see [Diagnostics Toolbar Buttons](#) for detailed descriptions of the operations for each button.
2. **Main Section** — the left column displays the item names; the right column displays the specifications or descriptions.
3. **Function Button** — in this case, only a **Back** (or sometimes an **ESC**) button is available; tap it to exit after viewing.

## Trouble Codes

### Read Codes



**Figure 4-12 Read Codes Screen**

This function retrieves and displays the DTCs from the vehicle's control system. The Read Codes screen varies for each vehicle being tested on some vehicles, freeze frame data can also be retrieved for viewing. The sample Read Codes screen displays as above.

1. **Diagnostics Toolbar Buttons** — see [Diagnostics Toolbar Buttons](#) for details.
2. **Main Section**

- Code Column — displays the retrieved codes from the vehicle.
- Status Column — indicates the status of the retrieved codes.
- Description Column — provides detailed descriptions for the retrieved codes.
- Snowflake Icon — only displays when Freeze Frame data is available for viewing; Selecting displays a data screen, which looks very similar to the Read Codes interface, therefore same operation methods may be applied.
- DTC Guide — checks the related help information.

### 3. Function Button

**Table 4-4 Function Buttons in Trouble Codes**

Name	Description
<b>DTC guide</b>	Checks the related help information.
<b>Freeze frame</b>	Displays when freeze frame data is available for viewing. Tap the icon to display a data screen. The Freeze Frame interface is similar to the Read Codes interface and shares similar operations.
<b>Search</b>	Searches the selected DTC for additional information on the Internet.
<b>Erase codes</b>	Erases codes from the ECU. It is recommended that DTCs are read and needed repairs are performed before erasing codes.
<b>Read codes</b>	Retrieves and displays the DTCs from the vehicle control system. The Read Codes screen varies for each vehicle being tested.
<b>ESC</b>	Returns to the previous screen or exit Trouble Code.

#### *Erase Codes*

After reading the retrieved codes from the vehicle and making repairs, you can erase the codes from the vehicle using this function. Before performing this function, make sure the vehicle's ignition key is in the ON (RUN) position with the engine off.

#### ➤ **To erase codes**

1. Tap **Trouble Codes** from the Function Menu.
2. Tap **Erase Codes**. A warning message displays to inform you of data loss when this function is applied.
  - a) Tap **Yes** to continue. A confirmation screen displays when the operation is successfully done.



- b) Tap **No** to exit.
3. Tap **ESC** on the confirming screen to exit Erase Codes.
4. Check the Read Codes function again to ensure the operation is successful.

## Live Data

When this function is selected, the screen displays the data list for the selected module. The items available for any control module vary from one vehicle to another. The parameters display in the order that they are transmitted by the ECU, so expect variation between vehicles.

Gesture scrolling allows you to quickly move through the data list. Simply swipe the screen up or down to reposition the parameters being displayed if the data covers more than one screen. The figure below shows a typical Live Data screen:



**Figure 4-13 Live Data Screen**

### 1. Diagnostics Toolbar Buttons

### 2. Main Section

- Name Column — this column displays the parameters.
  - a) Check Box — tap the check box at the left side of the parameter to select the item. Tap the check box again to deselect the item.
  - b) Drop-down Button — tap the drop-down button at the right side of a parameter to open a submenu, and view data display-mode options.
- Value Column — displays the values of the parameters.
- Unit Column — displays the unit of the parameter values.

➤ **To change the Unit mode**

- Tap the **Settings** button in the top toolbar and select a required mode. See [Units](#) for more information.

*Display Mode*

There are four types of display modes available for data viewing, allowing you to view various types of parameters in the most suitable way for data check-ups. Tap the drop-down button on the right side of a parameter to open a submenu. A total of 7 buttons will be displayed: The 4 buttons on the left represent different data display modes, plus an **Information button** (active when additional information is available), an **Unit Change** button (for switching the unit of displayed data), and a **Trigger** button (tap to open the "Trigger Settings" window).



**Figure 4-14 Display Mode Screenshot**

Each parameter item displays the selected mode independently.

- ① **Analog Gauge Mode** — displays the parameters in gauge charts.
- ② **Text Mode** — the default mode that displays the parameters as a text list.

**NOTE**

Some status parameters, such as a switch reading, like ON, OFF, ACTIVE, and ABORT, etc., can only be displayed in Text Mode. Others, such as a sensor reading, can be displayed in both text and graph modes.

- ③ **Waveform Mode** — displays the parameters in waveform graphs

In this mode, five control buttons will appear to the right of the parameter, allowing you to manipulate the display status.



**Figure 4-15 Waveform Graph Mode Screen**

- 1) Settings Button (SetY) — sets the minimum and maximum value of the Y-axis.
- 2) Scale Button — changes the scale values. Which can be used to change the scale values of the X-axis and Y-axis of the graph. There are four scales available for the X-axis: x1, x2, x4 and x8, and three scales available for the Y-axis: x1, x2, and x4.
- 3) Edit Button — edits the waveform color and line thickness.
- 4) Zoom-in Button — tap once to display the selected data graph in full screen.
- 5) Exit Button — tap to exit waveform mode.

**Full Screen Display** — this option is only available in waveform mode, and mostly used in Graph Merge status for data comparison. There are four control buttons available on the top right side of the screen under this mode.

- Edit Button — tapping this button opens an edit window, on which you can set the waveform color and the line thickness displayed for the selected parameter item.
- Scale Button — tap to change the scale values below the waveform graph. There are four scales available for the X-axis: x1, x2, x4 and x8. There are three scales available for the Y-axis: x1, x2, and x4.
- Zoom-out Button — exits full screen display.
- Exit Button — tap to exit Waveform Mode.

➤ **To edit the waveform color and line thickness in a data graph**

1. Select parameters to display in waveform mode.
2. Tap the **Edit** button, and an edit window will appear.

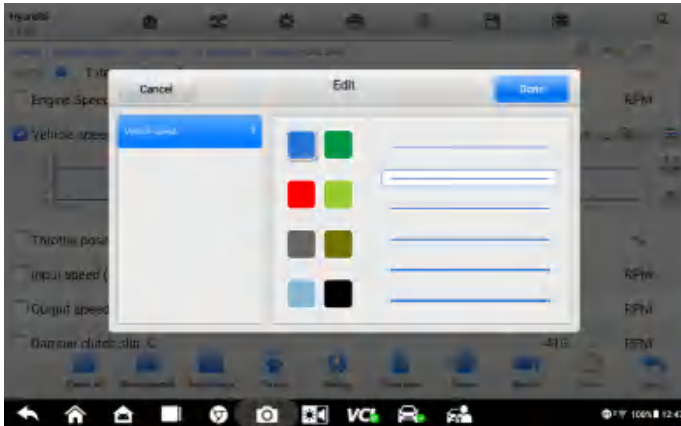

**Figure 4-16 Waveform Edit Screen**

3. The parameter is selected automatically in the left column.
4. Select a color from the middle column.
5. Select a line thickness from the right column.
6. Tap **Done** to save the setting and exit, or tap **Cancel** to exit without saving.

ⓘ **NOTE**

In the full screen display mode, you can edit the waveform's color and line thickness by tapping the **Edit** button on the upper-right side of the screen.

- ④ Digital Gauge Mode — displays the parameters in form of a digital gauge graph.

**Trigger Settings**

Tap the drop-down button to the right of a parameter to open a submenu. The **Trigger** button is the last one in the submenu. Tap to display the Trigger Settings window.

On the Trigger Settings screen, you can set a standard range by filling in minimum and maximum values. When exceeding these values, the trigger function will be executed and the device will automatically record and save the generated data. You can review the saved live data by tapping the **Review** button at the bottom of the screen.

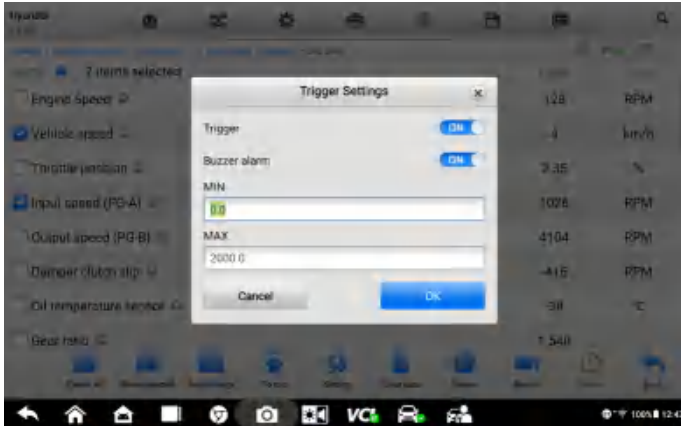

**Figure 4-17 Trigger Settings Screen**

Two buttons and two input boxes are available in the Trigger Settings window.

- a) **Trigger** — switches the trigger on and off. The trigger is ON by default.
- b) **Buzzer alarm** — switches the alarm on and off. The alarm function makes a beeping sound as an alert when the data reading reaches the threshold values. The buzzer alarm will only sound at the first trigger.
- c) **MIN** — tap this input box to display a virtual keyboard to enter a lower threshold value.
- d) **MAX** — tap this input box to display a virtual keyboard to enter an upper threshold value.

➤ **To set a trigger**

- 1. Tap the drop-down button to the right of a parameter to open a submenu.
- 2. Tap the **Trigger** button to the right of the submenu to open the Trigger Settings window.
- 3. Tap the **MIN** input box and enter the minimum threshold value.
- 4. Tap the **MAX** input box and enter the maximum threshold value.
- 5. Tap **OK** to save the settings and return to the Live Data screen, or tap **Cancel** to exit without saving.

When the trigger is set, a trigger mark appears in front of the parameter. The mark is gray when it is not triggered, and turns orange when triggered. Moreover, two horizontal lines appear on each of the data graphs (when Waveform Mode is applied) to indicate

the alarm point. The threshold lines are shown in different colors to differentiate them from the parameter waveforms.

### 3. Function Buttons

The operations of the function buttons on the Live Data screen are described below:

- ✧ **Cancel All** — tap to cancel all selected parameters. Up to 50 parameters can be selected at one time.
- ✧ **Show Selected/Show All** — tap this button to switch between the two options; one displays the selected parameter, the other displays all available items.
- ✧ **Graph Merge** — tap to merge selected data graphs (for Waveform Mode only). This function is very useful when comparing different parameters.

---

#### NOTE

This mode supports a Graph Merge of 2 to 5 digital parameters. Non-digital parameters are not supported.

---

#### ➤ To merge selected data graphs

- 1) Select parameters to be merged.
- 2) Tap the **Graph Merge** button at the bottom of the Live Data screen.
  - a) This mode only supports parameters that can be represented digitally. If non-digital parameters are selected, a message will display advising the user that the selected parameters are not supported in this mode and to select 2 to 5 digital parameters. Tap the **Got It** button to return to the previous screen and select supported parameters.
  - b) If the selected parameters are not supported in this mode, a message will display advising the user to select parameters that are supported. A message will also display if more than 5 parameters have been selected. Please select 2 to 5 of the supported parameters and tap the **OK** button to merge.
- 3) Tap the **Cancel Merging** button at the bottom of the Live Data screen to cancel merging.

✧ **To Top** — moves a selected item to the top of the list.

✧ **Setting** — tap to set the recording duration.

#### ➤ To set live data record duration

1. Tap the **Setting** button at the bottom of the Live Data screen.
2. Tap the > button to the right of **Recording Time After Trigger Bar** and select a time length.
3. Tap **OK** to save the settings and return to the Live Data Settings screen, or tap the “X” button on the upper-right corner to exit without saving.

4. Tap **Done** at the upper-right corner of the Live Data Setting screen to confirm and save the settings and return to the Live Data screen, or tap **Cancel** to exit without saving.

❖ **Clear Data** — tap to clear all cached live data.

❖ **Freeze** — displays a still capture retrieved data.

- Previous Frame — displays previous frame if the freeze frame data.
- Next Frame — advances to the next frame in the freeze frame data.
- Play/Pause — tap to play/pause the frozen data.
- Resume — tap to exit the freeze data mode and return to normal data display.

❖ **Record** — starts recording the live data of the selected data items. Tap the **Record** button at the bottom of the Live Data screen. A message will display prompting user to select parameters to record. Tap the **Got It** button to confirm. Scroll down and select data to record. Tap the **Record** button to start recording. Tap the **Resume** button to stop recording. The recorded live data can be viewed in the Review section at the bottom of the Live Data screen or in the Data Manager.

❖ **Review** — reviews the recorded data. Tap to display a recording list, and select an item to review.

---

## NOTE

Only data recorded during the current operation can be reviewed on the Live Data screen. All historical recorded data can be reviewed in "Review Data" in the Data Manager application.

---

- Previous Frame — switches to the previous frame of recorded data.
- Next Frame — switches to the next frame of recorded data.
- Play/Pause — tap to play/pause recorded data.
- Show Selected — displays the selected parameters.
- Graph Merge — merges selected data graphs.
- Back — exits the Review screen and returns to the Live Data screen.

❖ **Back** — returns to the previous screen or exits the function.

## Active Test

The Active Test function is used to access vehicle-specific subsystem and component tests. Available tests vary by manufacturer, year, and model.

During an active test, the tester outputs commands to the ECU in order to drive the actuators. This test determines the integrity of the system or parts by reading the engine ECU data, or by monitoring the operation of the actuators, such as toggling a solenoid, relay, or switch, between two operating states.

Selecting **Active Test** opens a menu of test options that varies by make and model. Selecting a menu option activates the test. Follow on-screen instructions while performing tests. How and what information is presented on the screen varies according to the type of test being performed. Some toggle and variable control tests display Active Test Controls at the top of the screen with data stream information below, or vice versa.



**Figure 4-18 Active Test Screen**

The function buttons at the lower-right corner of the Active Test screen manipulate the test signals. The operational instructions are displayed on the main section of the test screen. Simply follow the on-screen instructions and make appropriate selections to complete the tests. Each time when an operation is successfully executed, the message such as “Command Finished”, “Activation Successful” or something similar displays.

Tap the **ESC** function button to exit the test when finished.

## Special Functions

These functions perform various component adaptations, allowing you to recalibrate or configure certain components after making repairs or replacement.

The main section of the Adaptation Operation screen displays a list of operational and vehicle status information, which mainly consists of four parts:

1. The first part in the top line shows the description of the operation being performed, and the execution status is displayed on the right, such as Completed, or Activated, etc.
2. The second part shows the preconditions or requirements for executing the operation being selected.
3. The third part displays the current conditions of the vehicle control module being learned for comparison to the preconditions suggested by the second part. If the



current condition of the control module is out of the suggested limit value, then it must be adjusted to meet the requirement.

4. The last part displays the instruction of how to use the functional button at the lower right corner of the screen to manipulate the teach-in operations.

Read the information carefully and check the vehicle condition accordingly, when you are sure that the vehicle is ready to perform the adaptation, simply follow the instruction provided to make appropriate selections. When the operation is done, an execution status message such as Completed, Finished or Successful, displays.

Tap the **ESC** button to exit the function.

## Generic OBDII Operations

---

A fast-access option for OBDII/EOBD vehicle diagnosis is available on the Vehicle Menu screen. This option presents a quick way to check for DTCs, isolate the cause of an illuminated Malfunction Indicator Lamp (MIL), check monitor status prior to emissions certification testing, verify repairs, and perform a number of other services that are emissions-related. The OBD direct access option is also used for testing OBDII/EOBD compliant vehicles that are not included in the Diagnostics database.

Functions of the diagnostics toolbar buttons at the top of the screen are the same as those available for specific vehicle diagnostics. See [Diagnostics Toolbar Buttons](#) for details.

### General Procedure

#### ➤ To access the OBDII/EOBD diagnostics functions

1. Tap the **Diagnostics** application button from the MaxiCOM Job Menu. The Vehicle Menu displays.
2. Tap the **EOBD** button. There are two options to establish communication with the vehicle.
  - Auto Scan — select to establish communication using each protocol in order to determine which one the vehicle is broadcasting on.
  - Protocol — select to open a submenu of various protocols. A communication protocol is a standardized way of data communication between an ECU and a diagnostic tool. Global OBD may use several different communication protocols.

3. Select a specific protocol if the **Protocol** option is selected. Wait for the Function menu screen to appear.



**Figure 4-19 Function Menu**

4. Select a function option to continue.
  - DTC & FFD
  - I/M Readiness
  - Live Data
  - O<sub>2</sub> Sensor Monitor
  - On-Board Monitor
  - Component Test
  - Vehicle Information
  - Vehicle Status

**NOTE**

Some functions are supported only on certain vehicles.

## Function Descriptions

This section describes the various functions of each diagnostics option:

### *DTC & FFD*

When this function is selected, the screen displays a list of Stored Codes and Pending Codes. When the Freeze Frame data of certain DTCs are available for viewing, a snowflake icon will display on the right side of the DTC item.

The Erase Codes function can be applied by tapping the **Erase codes** button at the bottom of the screen.

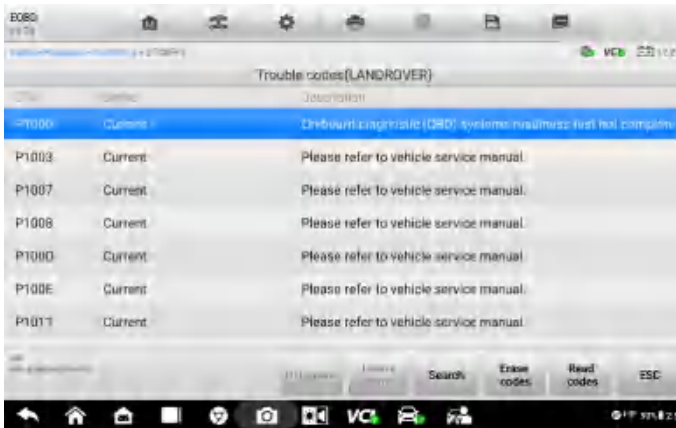

**Figure 4-20 DTC & FFD Screen**

- **Stored Codes**

Stored codes are the current emissions related DTCs from the ECU of the vehicle. OBDII/EOBD Codes have a priority according to their emission severity, with higher priority codes overwriting lower priority codes. The priority of the code determines the illumination of the Malfunction Indicator Light (MIL) and the codes erase procedure. Manufacturers rank codes differently, so expect to see differences between vehicles.

- **Pending Codes**

These are codes for which setting conditions were met during the last drive cycle, but need to be met on two or more consecutive drive cycles before the DTC actually sets. The intended use of this service is to assist the service technician after a vehicle repair

and after clearing diagnostic information, by reporting test results after a single driving cycle.

- a) If a test fails during the driving cycle, the DTC associated with that test is reported. If the pending fault does not occur again within 40 to 80 warm-up cycles, the fault is automatically cleared from memory.
  - b) Test results reported by this service do not necessarily indicate a faulty component or system. If test results indicate another failure after additional driving, then a DTC is set to indicate a faulty component or system, and the MIL is illuminated.
- Freeze Frame

In most cases the stored frame is the last DTC that occurred. Certain DTCs, those that have a greater impact on vehicle emission, have a higher priority. In these cases, the highest priority DTC is the one for which the freeze frame records are retained. Freeze frame data includes a “snapshot” of critical parameter values at the time the DTC is set.

- Erase Codes

This option is used to clear all emissions related diagnostic data such as, DTCs, freeze frame data and manufacturer specific enhanced data from the vehicle’s ECU, and resets the I/M Readiness Monitor Status for all vehicle monitors to Not Ready or Not Complete status.

A confirmation screen displays when the clear codes option is selected to prevent accidental loss of data. Select **Yes** on the confirmation screen to continue, or **No** to exit.

### *I/M Readiness*

This function is used to check the readiness of the monitoring system. It is an excellent function to use prior to having a vehicle inspected for compliance to a state emissions program. Selecting **I/M Readiness** opens a submenu with two choices:

- Since DTCs Cleared — displays the status of monitors since the last time the DTCs were erased.
- This Driving Cycle — displays the status of monitors since the beginning of the current drive cycle.

### *Live Data*

This function displays the real time PID data from ECU. Displayed data includes analog inputs and outputs, digital inputs and outputs, and system status information broadcast on the vehicle data stream.

Live data can be displayed in various modes, see [Live Data](#) for detailed information.

### *O<sub>2</sub> Sensor Monitor*

This option allows retrieval and viewing of O<sub>2</sub> sensor monitor test results for the most recently performed tests from the vehicle's on-board computer.

The O<sub>2</sub> Sensor Monitor test function is not supported by vehicles which communicate using a Controller Area Network (CAN).

### *On-Board Monitor*

This option allows you to view the results of On-Board Monitor tests. The tests are useful after servicing or after erasing a vehicle's control module memory.

### *Component Test*

This service enables bi-directional control of the ECU so that the diagnostic tool is able to transmit control commands to operate the vehicle systems. This function is useful in determining how well the ECU responds to a command.

### *Vehicle Information*

The option displays the Vehicle Identification Number (VIN), the calibration identification, the Calibration Verification Number (CVN), and other information of the test vehicle.

### *Vehicle Status*

This item is used to check the current condition of the vehicle, including communication protocols of OBDII modules, retrieved codes amount, status of the Malfunction Indicator Light (MIL), and other additional information may be displayed.

# Service

---

The Service section is specially designed to provide quick access to the vehicle systems for various scheduled service and maintenance tasks. The typical service operation screen is a series of menu driven executive commands. By following the on-screen instructions to select appropriate execution options, enter correct values or data, and perform necessary actions. The application will display detailed instructions to complete selected service operations.

The most commonly performed service functions include:

- Oil Reset Service
- EPB Service
- BMS Service
- SAS Service
- DPF Service
- TPMS Service
- IMMO Service

After entering each special function, the displayed screen consists of two applications: **Diagnosis** and **Hot Functions**. The **Diagnosis** is for you to read/clear data since this is necessary after some special functions. **Hot Functions** consists of sub functions of the selected special function.

## Function Descriptions

This section describes the main functions for vehicle service:

### *Oil Reset Service*

This function allows you to perform reset for the Engine Oil Life system, which calculates an optimal oil life change interval depend on the vehicle driving conditions and climate. The Oil Life Reminder must be reset every time the oil is changed, so the system can calculate when the next oil change is required.

---

**ⓘ IMPORTANT**

Always reset the engine oil life to 100% after every oil change.

---

**🔧 NOTE**

All required work must be carried out before the service indicators are reset. Failure to do so may result in incorrect service values and cause DTCs to be stored by the relevant control module.

For some vehicles, the scan tool can reset additional service lights such as the maintenance cycle and service interval. On BMW vehicles for example, service resets include engine oil, spark plugs, front/rear brakes, coolant, particle filter, brake fluid, micro filter, vehicle inspection, exhaust emissions inspection and vehicle checks.

---

### *Electric Parking Brake (EPB) Service*

This function has a multitude of ways to maintain the electronic braking system safely and effectively. The applications include deactivating and activating the brake control system, assisting with brake fluid control, opening and closing brake pads, and setting brakes after disc or pad replacement.

#### **EPB Safety**

It may be dangerous to perform Electric Parking Brake (EPB) system maintenance, so before you begin the service work, please keep these rules in mind.

- ✓ Ensure that you are fully familiar with the braking system and its operation before commencing any work.
- ✓ The EPB control system may be required to be deactivated before carrying out any maintenance/diagnostic work on the brake system. This can be done from the tool menu.
- ✓ Only carry out maintenance work when the vehicle is stationary and on level ground.
- ✓ Ensure that the EPB control system is reactivated after the maintenance work has been completed.

---

 **NOTE**

Autel accepts no responsibility for any accident or injury arising from the maintenance of the Electric Parking Brake system.

---

### *Battery Management System (BMS) Service*

The Battery Management System (BMS) allows the tool to evaluate the battery charge state, monitor the close-circuit current, register the battery replacement, activate the rest state of the vehicle, and charge the battery via the diagnostic socket.

---

 **NOTE**

This function is not supported by all vehicles.

The sub functions and actual test screens of the BMS may vary by vehicle, please follow the on-screen instructions to make correct option selection.

---

The vehicle may use either a sealed lead-acid battery or an AGM (Absorbed Glass Mat) battery. Lead acid battery contains liquid sulphuric acid and can spill when overturned. AGM battery (known as VRLA battery, valve regulated lead acid) also contains sulphuric acid, but the acid is contained in glass mats between terminal plates.

It is recommended that the replacement aftermarket battery has the same specifications, such as capacity and type, as the exiting battery. If the original battery is replaced with a different type of battery (e.g. a lead-acid battery is replaced with an AGM battery) or a battery with a different capacity (mAh), the vehicle may require reprogramming of the new battery type, in addition to, performing the battery reset. Consult the vehicle manual for additional vehicle-specific information.

### *Steering Angle Sensor (SAS) Service*

Steering Angle Sensor Calibration permanently stores the current steering wheel position as the straight-ahead position in the steering angle sensor EEPROM. Therefore, the front wheels and the steering wheel must be set exactly to the straight-ahead position before calibration. In addition, the vehicle identification number (VIN) is also read from the instrument cluster and stored permanently in the steering angle sensor EEPROM. On successful completion of calibration, the steering angle sensor fault memory is automatically cleared.

Calibration must always be carried out after the following operations:

- Steering wheel replacement
- Steering angle sensor replacement
- Any maintenance that involves opening the connector hub from the steering angle sensor to the column
- Any maintenance or repair work on the steering linkage, steering gear or other related mechanism



- Wheel alignment or wheel track adjustment
- Accident repairs where damage to the steering angle sensor, SAS assembly, or any part of the steering system may have occurred.

---

 **NOTE**

AUTEL accepts no responsibility for any accident or injury arising from servicing the SAS system. When interpreting DTCs retrieved from the vehicle, always follow the manufacturer's recommendation for repair.

All software screens shown in this manual are examples, actual test screens may vary by test vehicle. Observe the menu titles and on-screen instructions to make correct option selections.

Before starting the procedure, make sure the vehicle has ESC button. Look for the button on dash.

---

### *Diesel Particle Filter (DPF) Service*

The DPF function allows you to carry out numerous functions to the Diesel Particulate Filter system without having to send your car to a main dealer. The tool will manage DPF regeneration, DPF component replacement teach-in and DPF teach-in after replacing the engine control unit.

The ECM monitors driving style and selects a suitable time to employ regeneration. Cars driven a lot at idling speed and low load will attempt to regenerate earlier than cars driven more with higher load and speed. In order for regeneration to take place, a prolonged high exhaust temperature must be obtained.

In the event of the car being driven in such a way that regeneration is not possible, i.e. frequent short journeys, a diagnostic trouble code will eventually be registered in addition to the DPF light and "Check Engine" indicators displaying. A service regeneration can be requested in the workshop using the diagnostic tool.

Before performing a forced DPF regeneration using the tool, check the following items:

- The fuel light is not on.
- No DPF-relevant faults stored in system.
- The vehicle has the specified engine oil.
- The oil for diesel is not contaminated.

---

 **IMPORTANT**

Before diagnosing a problem vehicle and attempting to perform an emergency regeneration, it is important to obtain a full diagnostic log and read out relevant measured value blocks.

---

---

 **NOTE**

The DPF will not regenerate if the engine management light is on, or there is a faulty EGR valve.

The ECU must be re-adapted when replacing the DPF and when topping up the fuel additive Eolys.

If the vehicle needs to be driven in order to perform a DPF service, ALWAYS have a second person help you. One person should drive the vehicle while the other person observes the screen on the Tool. Do not attempt to drive and observe the scan tool at the same time. This is dangerous and puts your life and the lives of other motorists and pedestrians at risk.

---

### *Tire Pressure Monitoring System (TPMS) Service*

This function allows you to quickly look up the tire sensor IDs from the vehicle's ECU, as well as to perform TPMS programming and reset procedures after tire sensors are replaced.

### *Immobilizer (IMMO) Service*

An immobilizer is an anti-theft mechanism that prevents an automobile's engine from starting unless the correct ignition key or other device is present. This device prevents thieves from starting the car by a method known as hot wiring. Most new vehicles have an immobilizer as standard equipment. An important advantage of this system is that it doesn't require the car owner to activate it; it operates automatically. An immobilizer is considered as providing much more effective anti-theft protection than an audible alarm alone; many auto insurance companies offer lower rates for vehicles that are equipped with an immobilizer.

As an anti-theft device, an immobilizer disables one of the systems needed to start a car's engine, usually the fuel supply or the ignition. This is accomplished by radio frequency identification between a transponder in the ignition key and a device called a radio frequency reader in the steering column. When the key is placed in the ignition, the transponder sends a signal with a unique identification code to the reader, which relays it to a receiver in the vehicle's computer control module. If the code is correct, the computer allows the fuel supply and ignition systems to operate and start the engine. If the code is incorrect or absent, the computer disables the system, and the engine will be unable to start until the correct key is placed in the ignition.

The IMMO service enables you to disable the lost vehicle keys and program the replacement key fob. It could be one replacement key fob or more, depending on your needs.

➤ **To program the replacement key fob(s)**

1. Tap **IMMO KEYS** after entering the **Service** function from the Job Menu.
2. Tap **Automatic Selection** or **Manual Selection** to acquire vehicle VIN information and tap **Yes** to confirm.
3. Tap **Erase/Program all key fobs** in the IMMO function list after it is displayed, the list may vary for different vehicles being tested.

---

 **NOTE**

To complete key fob programming, you need to acquire the Security Code, which can be acquired through the Security Code Read function in hot functions.

Before programming, please check and erase the fault codes

---

*ABS/SRS Services*

This function allows you to perform various bi-directional tests to check the operating conditions of both the Anti-lock Braking System and the Supplemental Restraint System, such as Automated Bleeding, Pump Motor Test, and checking module information.

---

## Coding

---

Since the introduction of OBDII and leading up to modern Hybrids and EVs, computers and software in cars have been expanding at an exponential rate. In-car software is becoming one of the leading needs for service, and updating software may be the only way to fix some of these issues:

- Drivability
- Fuel Efficiency
- Power Loss
- Fault Codes
- Durability of Mechanical Parts

The Coding function is used to re-flash the vehicle control modules, it allows you to update the computer software on the vehicle to the latest version, as well as to reprogram adaptive data for certain components after making repairs or replacements.

Available coding operations vary by the test vehicle, and only the available operations display in the menu.

Selecting the Coding function opens a menu of operation options that varies by make and model. Follow all screen instructions while performing the coding operations. How and what information is presented on the screen varies according to the type of operation being performed.

# Variant Coding

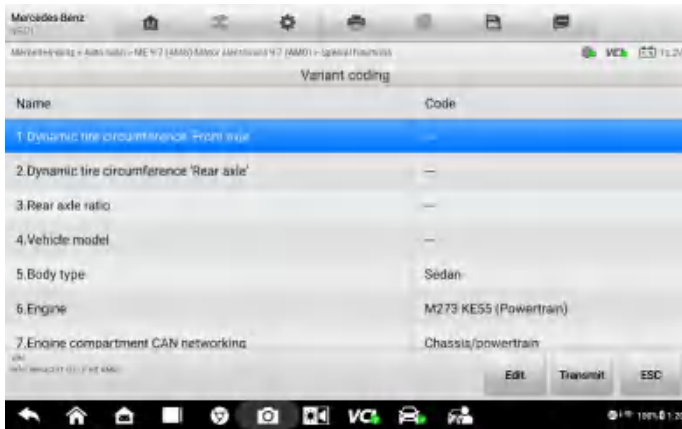

**Figure 4-21 Variant Coding Screen**

The main section of the Variant Coding screen displays a list of vehicle components:

1. The top line on the list displays all available systems for coding on the left side, and the coding data or values on the right side.
2. The bottom line of the main section displays function buttons which allow you to perform the operation.

Check the vehicle condition and the coding information carefully, and use the function buttons to edit Codes for the corresponding components. Tap **Send** when you finish editing all the items. When the operation is complete, status message (Completed, Finished or Successful) may appear.

Tap the **ESC** button to exit the function.

# Exit Diagnostics

---

The Diagnostics application remains open as long as there is an active communication with the vehicle. You must exit the diagnostics operation interface to stop all communications with the vehicle before closing the Diagnostics application.

---

## NOTE

Damage to the vehicle Electronic Control Module (ECM) may occur if communication is disrupted. Make sure all connections, such as data cable, USB cable, and wireless or wired network, are properly connected at all times during testing. Exit all tests before disconnecting the test cable or powering down the tool.

---

### ➤ To exit the Diagnostics application

- From an active diagnostic screen, tap the **Back** or **ESC** function button to exit a diagnostic session step-by-step; Or
- Tap the **Vehicle Swap** button on the diagnostics toolbar to return to the Vehicle Menu screen. From the vehicle menu screen, tap the **Home** button on the top toolbar; or tap the **Back** button on the navigation bar at the bottom of the screen. Or
- Tap the **Recent Apps** button on the diagnostics navigation buttons to displays a list of currently running applications. From the list of currently running applications, swipe the **MaxiCOM Diagnostics** image to the right or the left side to remove the app.

Now, the Diagnostics application is no longer communicating with the vehicle and it is safe to open other MaxiCOM applications, or exit the MaxiCOM Diagnostic System and return to the Android System's Home screen.

# 5. Data Manager

The Data Manager application is used to store, print, and review the saved files.







Selecting the Data Manager application opens the file system menu. There are nine types of information files to be viewed or played back.





**Figure 5-1 Data Manager Main Screen**

The table below describes each of the function buttons in the Data Manager.

**Table 5-1 Buttons in Data Manager**

Button	Name	Description
	<b>Vehicle History</b>	Tap to view the diagnostic records.
	<b>Workshop Information</b>	Tap to view or edit the workshop profile information.
	<b>Customer</b>	Tap to create a new customer account file.
	<b>Image</b>	Tap to view saved screenshots.
	<b>Report</b>	Tap to view and edit saved reports.
	<b>PDF</b>	Tap to view diagnostic reports.

Button	Name	Description
	<b>Review Data</b>	Tap to view recorded data.
	<b>Uninstall Apps</b>	Tap to uninstall applications.
	<b>Data Logging</b>	Tap to view communications with Autel support service and ECU information for the test vehicle. The saved data can be reported and sent to the technical center via the Internet.

Data Manager Operations are based on toolbar controls, details are explained in the following sections.

## Vehicle History

This function stores vehicle test records, including vehicle information and the retrieved DTCs from previous diagnostic sessions. Test information is summarized and displayed in an easy-to-read table listing. The Vehicle History also provides direct access to the previously tested vehicle and allows you to directly restart a diagnostic session without needing to perform auto or manual vehicle selection.

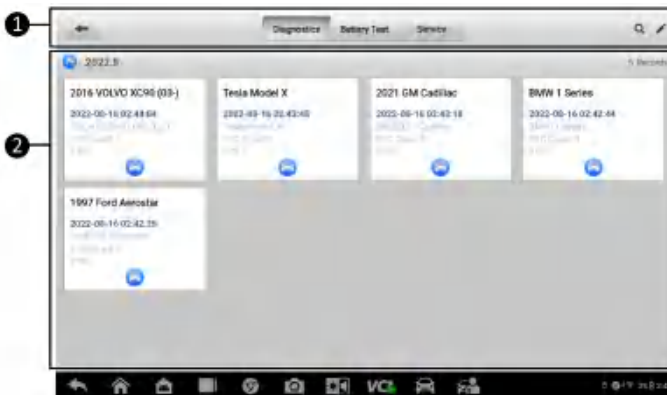

**Figure 5-2 Vehicle History Screen**

- ① Top Toolbar Buttons — navigation and application controls.
- ② Main Section — displays all the test records.

➤ **To activate a test session for a recorded vehicle**

1. Tap **Data Manager** on the MaxiCOM Job Menu.
2. Select **Vehicle History** to open the screen. Tap **Diagnostics** or **Service** to select diagnostic test records or service test records.
3. Tap **Diagnostics** icon at the bottom of the thumbnail of a vehicle record item.
4. The Diagnostics screen of the vehicle displays and a new diagnostics session is activated (See [Diagnostics](#) for detailed instructions on vehicle diagnostics operations), or select a vehicle thumbnail to select a record. A Test Records window appears. Review the recorded information of the test vehicle, and tap the **Diagnostics** button on the upper-right corner to continue diagnostics.

## Test Records

A Test Record is a detailed data form of the tested vehicle, which includes general vehicle information, service record, customer information, and the diagnostic trouble codes retrieved from previous test sessions. Technician Notes will also display if present.

 **NOTE**

The MaxiCOM tablet must establish a connection to the VCI to restart test sessions on a previously tested vehicles.



*Figure 5-3 Test Records Sheet*

➤ **To edit a previous Test Record**

1. Tap **Data Manager** in the MaxiCOM main screen.
2. Select **Vehicle History**.
3. Select a specific vehicle history record thumbnail from the main section. The test record will display.



4. Tap the **Edit** button (the pen icon) to start editing.
5. Tap each item to enter information or attach files or images.
6. Tap **Add a Customer** to associate the Test Records sheet to an existing customer account, or add a new account to be associated with the test vehicle record. See [Customer](#) for more information.
7. Tap **Done** to save the updated record, or tap **Cancel** to exit without saving.

**NOTE**

The vehicle VIN, license number, and customer account are associated by default. Vehicle records will automatically be associated using this vehicle and customer identification.

## Workshop Information

Workshop Information allows you to enter, edit, and save detailed workshop profile information, such as shop name, address, phone number, and other remarks, which, when printing vehicle diagnostics reports and other associated test files, will appear as the header of your printed documents.

**Figure 5-4 Workshop Information Sheet**

➤ **To edit the Workshop information sheet**

1. Tap **Data Manager** on the MaxiCOM Main Screen.
2. Select **Workshop Information**.
3. Tap on each field to enter the corresponding information.
4. Tap **Done** to save the updated workshop information, or tap **Cancel** to exit without saving.

# Customer

---

The Customer function allows you to create and edit customer accounts. It helps you to save and organize all customer accounts associated with the test vehicle records.

➤ **To create a customer account**

1. Tap the **Data Manager** application on the Job Menu.
2. Select **Customer**.
3. Tap the **Add a customer** button. A blank information form appears. Tap each field to enter the appropriate information.

---

 **NOTE**

Required fields are denoted by an asterisk.

---

4. For customers with more than one vehicle for service, tap **Add New Vehicle Information**. To delete the added vehicle information, tap the  button.
5. Tap **Complete** on the upper-right corner of the screen to save the customer information, or tap **Cancel** to exit without saving.

➤ **To edit a customer account**

1. Tap **Data Manager** on the MaxiCOM Job Menu.
2. Select **Customer**.
3. Select a customer account by tapping the corresponding name card. The Customer Information record displays.
4. Tap **Edit** on the top toolbar to start editing.
5. Tap on the input field to edit the information.
6. Tap **Complete** to save the updated information, or tap **Cancel** to exit without saving.

➤ **To delete a customer account**

1. Tap **Data Manager** on the MaxiCOM Job Menu.
2. Select **Customer**.
3. Select a customer account by tapping the corresponding name card. The Customer Information record appears.
4. Tap **Edit** on the top toolbar to start editing.
5. Tap **Delete** button on the top of the screen. A reminder message appears.
6. Tap **OK** to confirm the command and delete the account. Tap **Cancel** to cancel the request.

# Image









The Image section is a database containing all captured screenshots in .png file format.



**Figure 5-5 Image Database Screen**

1. **Toolbar Buttons** — edits, prints, deletes the images. See [Table 5-2 Toolbar Buttons Description](#) for details.
2. **Main Section** — displays the stored images.

**Table 5-2 Toolbar Buttons Description**

Name	Button	Description
Back		Returns to the previous screen.
Search		Enters the search page.
Edit		Displays the editing toolbar to print, delete or view images.
Cancel		Closes the editing toolbar or cancel file search.
Search		Quickly searches the image by entering the time of the screenshot.
Print		Prints the selected image.
Delete		Deletes the selected image.
Email		Sends the selected image via email.

➤ **To edit image(s)**

1. Select **Data Manager** from the MaxiCOM Job Menu.
2. Select **Image** to access the images.
  - ◆ Tap the **Edit** icon on the top-right corner of the screen. The editing screen will appear.
    - a) Tap the **Delete** icon to open a drop-down list. Tap **Delete all** to delete all images. Or
    - b) Select the image(s) you want to edit by tapping the check box at the bottom-right corner of the image.
    - c) Tap the **Delete** icon to open a drop-down list. Tap **Delete Selected** to delete the selected images.
    - d) Tap **...** to open a drop-down list. Tap the **Print** icon to print the selected image(s). Tap the **Email** icon to attach the selected image(s) to an email.
  - ◆ Tap the image need to be deleted/edited.
    - a) Tap the **Delete** icon to delete the image. Or
    - b) Tap the **Print** icon to print the selected image. Tap the **Email** icon to attach the selected image to an email.

## Report

---

This section stores and displays all diagnostic reports. The reports stored in the Report will be uploaded automatically when you set ON to the Report upload to Cloud on Scan Report. Tap one of the reports to view it or share it to cloud. Select **View Local** reports to open it. Tap **Report Cloud Sharing** to share.

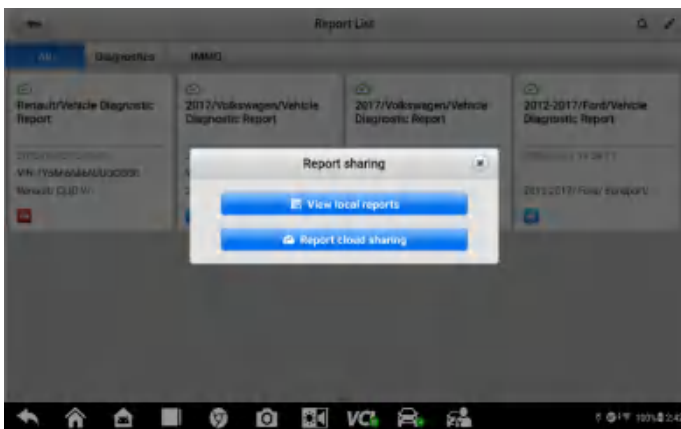

**Figure 5-6 Report Screen**

➤ **To share a report**

1. Tap the **Data Manager** application on the MaxiCOM Job Menu.
2. Tap **Report** to access the “Report List” screen.
3. Tap a report record to display the “Record Sharing” dialog box.
4. Tap **Report Cloud Sharing**.
5. Scan the QR code or tap **Send Email** or **Send SMS** to share the report.

## PDF Files

---

The PDF section stores and displays all PDF files of saved data. After entering the PDF database, select a file to view.

This section uses the standard Adobe Acrobat Reader application for file viewing and editing. Please refer to the associated Adobe Acrobat Reader manual for more detailed instructions.

## Review Data

---

The Review Data function allows you to play back the recorded data frames from live data streams.

On the Review Data main screen, select a record to play back.

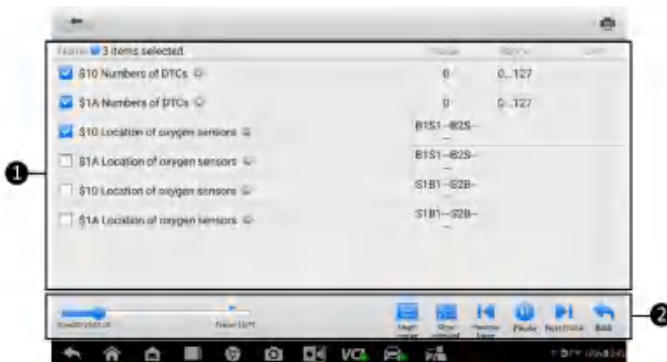

**Figure 5-7 Data Playback Screen**

1. Main Section — displays the recorded data frames.
2. Navigation Toolbar — allows you to manipulate data playback.

Use the Navigation Toolbar buttons to play back the recorded data from frame to frame. Tap **Back** to exit data playback.

## Data Logging

---

The Data Logging section allows you to launch the Support platform directly to view all records of all sent or unsent (saved) data loggings on the diagnostic system. See [Data Logging](#) for details.

## Uninstall Apps

---

This section allows you to manage the software application installed on the MaxiCOM diagnostics system. Selecting this section opens a management screen, on which you can check all available vehicle diagnostics applications.

Select the vehicle software you want to delete by tapping on the vehicle brand icon, the selected item will display a blue tick at the bottom-right corner. Tap the **Delete** button on the top bar to delete the software from the system database.

# 6. Battery Test

The MaxiBAS BT506 is a battery and electrical system analysis tool that uses Adaptive Conductance, an advanced battery analysis method to produce a more accurate examination of the battery cold cranking ability and reserve capacity, which is vital to determining a battery's true health. The MaxiBAS BT506 enables technicians to view the health status of the vehicle's battery and electrical system. Together with the MaxiBAS BT506, this application can complete battery, starting, and charging systems tests and display the test results.

## MaxiBAS BT506 Tester

---

### Function Descriptions

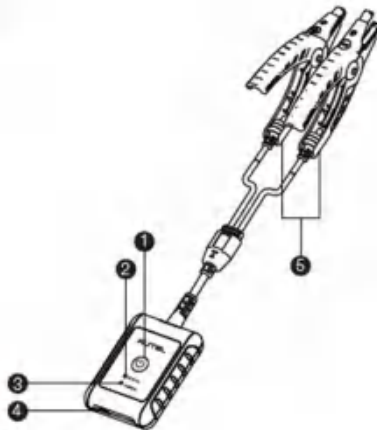

**Figure 6-1 MaxiBAS BT506 Tester**

1. Power Button
2. Status LED
3. Power LED
4. USB Port
5. Battery Clamp Cable

**Table 6-1 LED Description**

LED	Color	Description
<b>Status LED</b>	Flashing Green	The tester is communicating via USB cable.
	Flashing Blue	The tester is communicating via Bluetooth.
	Flashing Red	Battery clamps are connected to the wrong battery terminals.
<b>Power LED</b>	Solid Green	The tester is powered on and sufficiently charged.
	Flashing Green	The tester is charging. (Becomes solid green when battery is fully charged.)
	Solid Red	The device is in boot mode.
	Flashing Red	The battery level is low. Please charge.

## Power Sources

The MaxiBAS BT506 tester can receive power from the following sources:

- Internal battery pack
- AC/DC power supply

---

### **!** IMPORTANT

Do not charge the battery when the temperature is below 0 °C (32 °F) or above 45 °C (113 °F).

---

#### Internal Battery Pack

The MaxiBAS BT506 tester can be powered with the internal rechargeable battery.

#### AC/DC Power Supply — Using Power Adapter

The MaxiBAS BT506 tester can be powered from an electrical outlet using the AC/DC power adapter. The AC/DC power supply also charges the internal battery pack.



# Technical Specifications

*Table 6-2 Technical specifications*

Item	Description
Connectivity	<ul style="list-style-type: none"><li>● USB 2.0, type C</li><li>● Bluetooth 4.2</li></ul>
Input Voltage	5 V DC
Working Current	< 150 mA at 12 V DC
Internal Battery	3.7 V/800 mAh Lithium-ion polymer battery
CCA Range	100 to 2000 A
Voltage Range	6 to 36 V
Working Temperature	-10 to 50 °C (14 to 122 °F)
Storage Temperature	-20 to 60 °C (-4 to 140 °F)
Dimension (L x W x H)	107 mm (4.21") x 75 mm (2.95") x 26 mm (1.02") (clamp cable not included)
Weight	320 g (0.7 lbs.)

## Test Preparation

---

### Inspect the Battery

Before starting a test, observe the battery for:

- Cracking, buckling or leaking (If you see any of these defects, replace the battery.)
- Corroded, loose or damaged cables and connections (Repair or replace as needed.)
- Corrosion on the battery terminals, and dirt or acid on the case top (Clean the case and terminals using a wire brush and a mixture of water and baking soda.)

## Connect the Battery Tester

### ➤ To pair the BT506 with the MaxiCOM tablet

1. Press and hold the **Power** Button to turn on both the MaxiCOM tablet and BT506. Ensure that the units are sufficiently charged before using.
2. Enable **Bluetooth** on the MaxiCOM tablet by tapping **VCI Manager > BAS BT**, and the tablet automatically scans for an available tester for Bluetooth pairing. The device name will appear as “Maxi” suffixed with the device's serial number.
3. Check the serial number of your BT506 tester and select the desired device for pairing.
4. When paired successfully, the connection status will read as “Connected” and the Status LED will flash blue.

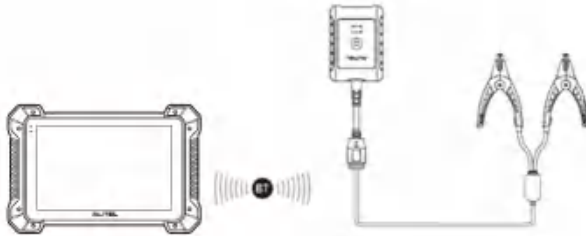

**Figure 6-2 Connecting with the Tablet**

### ➤ To connect to a battery

- Connect the red clamp to the positive (+) terminal and the black clamp to the negative (-) terminal of the battery.

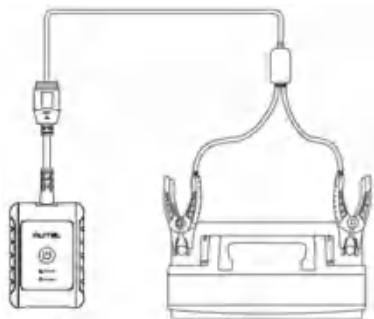

**Figure 6-3 Connecting to a Battery**

# In-vehicle Test

In-vehicle Test is used for testing batteries that are installed in a vehicle. An in-vehicle test includes Battery Test, Starter Test, and Generator Test. These tests help determine the health status of the battery, the starter, and the generator.

## ! IMPORTANT

Before using the diagnostic functions, download the desired vehicle software on the Update screen.

### ➤ Confirm Vehicle Information





1. Tap the **Battery Test** application from the Job Menu.
2. Select **In-vehicle Test**.
3. Confirm your vehicle information and make sure the VIN information is filled.
4. Confirm your battery information, including voltage, type, standard, and capacity. Tap **Next** to continue.



**Figure 6-4 Battery Information Screen**

Please refer to the table below for a list of buttons that may appear when accessing the functions:

**Table 6-3 Top Toolbar**

Name	Button	Description
<b>Battery Connection</b>		The value on the icon indicates the real-time voltage of the tested battery. In the battery test, the button will turn green if the battery is good; otherwise, it will turn red.
<b>Next</b>		Tap to proceed.
<b>Back</b>		Returns to the previous screen.
<b>Exit</b>		Returns to the Job Menu.

## Battery Test

1. Follow the on-screen instructions. Check the boxes once all required tasks are completed, and tap **Start Testing**.

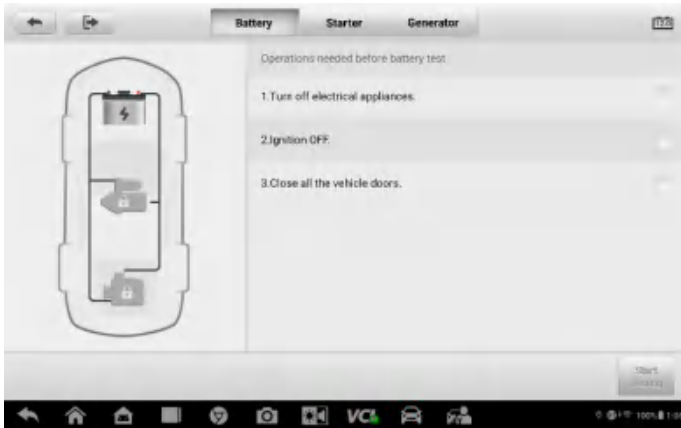

**Figure 6-5 Battery Screen**

2. Wait until the test is completed. The test results will be displayed on the tablet.



**Figure 6-6 Battery Test Results Screen**

### Battery Test Results

The battery test results include a color-coded results summary, a list of test data, and repair tips.

**Table 6-4 Test Results**

Result	Repair Tip
<b>Good Battery</b>	Battery is good.
<b>Good &amp; Recharge</b>	Battery is good but insufficiently charged. Recharge the battery.
<b>Charge &amp; Retest</b>	Battery requires charge to determine its condition.
<b>Bad Cell</b>	Replace the battery.
<b>Replace Battery</b>	Replace the battery.

**NOTE**

Please always complete the battery test before you proceed to the starter and generator tests.

# Starter Test

Follow the on-screen instructions to complete the test. Start the engine and let it idle. The test results will appear as follows:



**Figure 6-7 Starter Test Result Screen**

**Table 6-5 Starter Test Results**

Result	Description
<b>Cranking Normal</b>	The starter is good.
<b>Current Too Low</b>	Low momentary discharge capacity.
<b>Voltage Too Low</b>	Low battery storage capacity.
<b>Not Started</b>	The starter is not detected for starting.

# Generator Test

Follow the on-screen instructions to complete the test. The test results will appear as follows:

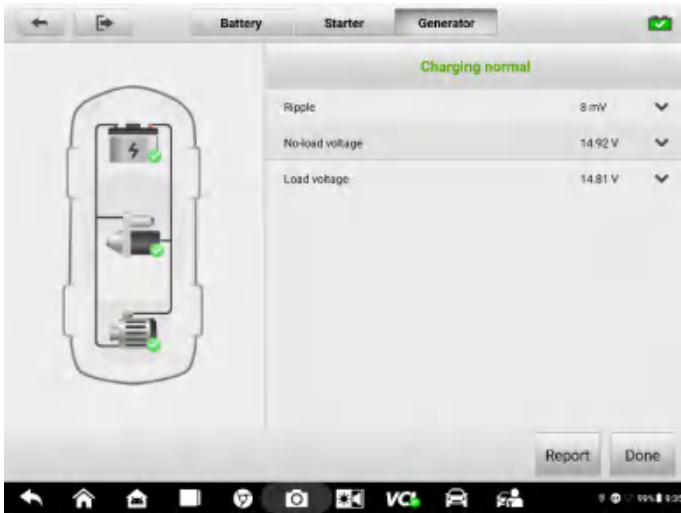

**Figure 6-8 Generator Test Results Screen**

**Table 6-6 Generator Test Results**

Result	Description
<b>Charging Normal</b>	The generator is functioning normally.
<b>Output Too Low</b>	<ul style="list-style-type: none"> <li>● The belt linking the starter and the generator is loose;</li> <li>● The cable linking the starter and battery is loose or corroded.</li> </ul>
<b>Output Too High</b>	<ul style="list-style-type: none"> <li>● The generator is not properly connected to the ground;</li> <li>● The voltage adjuster is broken and needs replacement.</li> </ul>
<b>Ripple Too Large</b>	The commutation diode is broken.
<b>No Output</b>	<ul style="list-style-type: none"> <li>● The cable is loose;</li> <li>● Some vehicles with power management systems do not provide path for charging due to the sufficient load capacity of the battery;</li> <li>● The generator or the voltage adjuster is broken and needs replacement.</li> </ul>

**NOTE**

To measure the current, connect the current clamp. Tap the **Settings** button on the main menu to enter the application. Swipe the Current Clamp toggle to turn it on.

## Out-vehicle Test

Out-vehicle Test is used to test the conditions of batteries that are not connected to a vehicle. This function aims to check the health status of the battery only.

### Test Procedure

➤ **To start the out-vehicle test**

1. Tap **Battery Test** application from the Job Menu.
2. Select **Out-vehicle Test**.
3. Connect the tester clamps to the battery terminals.
4. Select the appropriate battery type, rating standard, and CCA value. Tap **Start Testing** to start the test.

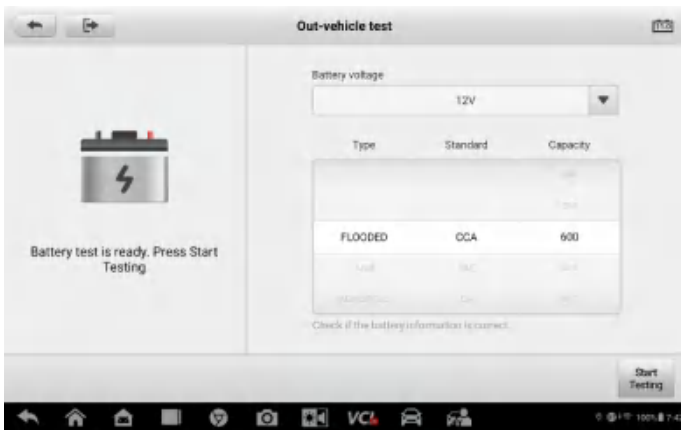

**Figure 6-9 Out-vehicle Test Screen**



- The test results will display in a few seconds.



**Figure 6-10 Out-vehicle Test Results Screen**

## Test Results

Icons are color-coded to indicate status.

**Table 6-7 Out-vehicle Test Results**

Result	Description
<b>Good Battery</b>	Battery meets required standards.
<b>Good &amp; Recharge</b>	Battery is good, but low on charge. Fully charge the battery. Check for causes of low charge.
<b>Charge &amp; Retest</b>	Battery requires charge to determine its condition.
<b>Replace Battery</b>	Battery fails to meet industry-accepted standards.
<b>Bad Cell</b>	Battery fails to meet industry-accepted standards.

# 7. User Feedback

The User Feedback application allows you to submit questions related to this product.



**Figure 7-1 User Feedback Screen**

➤ **To send new user feedback:**

1. Register the product online. See [Product Registration](#) for details.
2. Tap **User Feedback** on the MaxiCOM Job Menu. The device information is automatically synchronized with the online account.
3. Enter your telephone number/email address, feedback type, theme, and problem description. You can also attach a voice recording, photo, photo album, screen captures, image or PDF files to the form. To help us resolve the issue more efficiently, we recommend you complete the form as detailed as possible.
4. Tap **Submit** to send the completed form to Autel's online service center. The submitted feedback will be carefully read and handled by our support personnel.

# 8. Settings

Selecting Settings application opens a setup interface, on which you can adjust default settings and view information about the MaxiCOM system. The following options are available for the MaxiCOM system settings:

- Units
- Language
- Printing Settings
- Scan Report
- Push Notifications
- Auto update
- Vehicle List
- System Settings
- About

This section describes the operation procedures for the settings.

## Units

---

This option allows you to adjust the measurement unit for the diagnostics system.

### ➤ To adjust the unit settings

1. Tap the **Settings** application on the MaxiCOM Job Menu.
2. Tap the **Units** option on the left column.
3. Select the required measurement unit (Metric unit or Imperial unit). A check mark will display to the right of the selected unit.
4. Tap the **Home** button on the top left corner to return to the MaxiCOM Job Menu, or select another setting option for the system setup.

## Language

---

This option allows you to adjust the display language for the MaxiCOM system.

➤ **To adjust the language setting**

1. Tap the **Settings** application on the MaxiCOM Job Menu.
2. Tap the **Language** option on the left column.
3. Select the required language. A tick icon will display to the right of the selected language.
4. Tap the **Home** button on the top left corner to return to the MaxiCOM Job Menu, or select another setting option for the system setup.

## Printing Settings

---

This option allows you to print any data or information anywhere and anytime either via PC-Link or Wi-Fi.

➤ **To setup a printer connection**

1. Tap **Settings** application on the MaxiCOM Job Menu.
2. Tap the **Printing Settings** option on the left column.
3. Select the required mode to operate the printing (Print via PC-Link or Print via WI-FI), and a tick icon will display to the right of the selected mode.
4. Tap the **Home** button on the top left corner to return to the MaxiCOM Job Menu, or select another setting option for the system setup.

## Scan Report

---

This option automatically synchronizes the diagnostics information of the vehicle to the vehicle history and forms a diagnostics report for the user to upload. Tap the **ON/OFF** button to enable/disable the Scan Report or Report Upload to Cloud function. The button appears blue if the function is enabled and is gray if the function is disabled.

 **NOTE**

This function is available in limited areas.

---

# Push Notifications

---

This option allows you to manage notifications. The Notification Preference is turned on by default and cannot be turned off by users so that certain system notifications such as system security warnings will not be blocked. Internet access is required for receiving on-line messages.

➤ **To enable the Push Notifications function**

1. Tap the **Settings** application on the MaxiCOM Job Menu.
2. Tap the **Push Notifications** option on the left column.
3. Tap the **ON/OFF** button to enable or disable the Notifications Preferences function. If the function is enabled, the button turns blue; or if disabled, the button turns gray.
4. Tap the **Home** button on the top-left corner to return to the MaxiCOM Job Menu, or select another setting option for the system setup.

When the Notification Center function is turned on, and new messages are received by the MaxiCOM device, a notification message displays on the MaxiCOM Job Menu. Press on the message bar and drag it down, and the received messages are shown in the list, slide the list up or down to view all if the message list covers more than one screen.

Tapping a specific message launches the corresponding application.

For example, if you tap on an Update notification, the Update application will be launched.

# Auto Update

---

The Auto Update allows the tool to automatically update the MaxiCOM system and the vehicle software. All you need to do is to switch ON by tapping the button on the right side of each and set the desired automatic update time.

➤ **To set OS Update, MaxiCOM Update or Vehicle Update**

1. Tap the **Settings** application on the MaxiCOM Job Menu.
2. Tap the **Auto Update** option on the left column. The three auto update items list will appear on the right.
3. Switch **ON** the button on the right of item that you want to auto update.
4. Tap on the time to set a specific time for update — you can drag the small circle around the tip of the pointer of the clock or tap on the keyboard icon to manually enter the time.
5. Tap **OK** to complete the time setting.

---

## NOTE

An Internet connection is necessary for auto update to work properly. Make sure the device is connected to the Internet during your scheduled time.

---

## Vehicle List

---

This option allows you to sort the vehicles either by alphabetic order or by frequency of use.

### ➤ To adjust the vehicle list setting

1. Tap the **Settings** application on the MaxiCOM Job Menu.
2. Tap the **Vehicle List** on the left column.
3. Tap to choose **Sort by frequency of use** or **Sort by alphabetical order**. A check will appear to the right of the currently selected sort type.
4. Tap the **Home** button on the top left corner to return to the MaxiCOM Job Menu, or select another setting option for the system setup.

## System Settings

---

This option provides you with a direct access to the Android background system settings interface, on which you can adjust various system settings for the Android operating system, regarding wireless and networks settings, various device settings such as sound and display, as well as system security settings, and check associated information about the Android system. Refer to your Android documentation for additional information.

## About

---

The About option provides information of the MaxiCOM diagnostic device regarding the product name, version, hardware, and serial number, etc.

### ➤ To check the MaxiCOM product information in About

1. Tap the **Settings** application on the MaxiCOM Job Menu.
2. Tap the **About** option on the left column. The product information screen will appear on the right.
3. Tap the **Home** button on the top left corner to return to the MaxiCOM Job Menu, or select another setting option for the system setup.

# 9. Update

The Update application allows you to download the latest released software. The updates can improve the MaxiCOM applications' capabilities, typically by adding new tests, new models or enhanced applications to the database.

The tablet automatically searches for available updates for all the MaxiCOM software when it is connected to the Internet. Any updates that are found can be downloaded and installed on the device. This section describes installing an update to the MaxiCOM Diagnostics System.

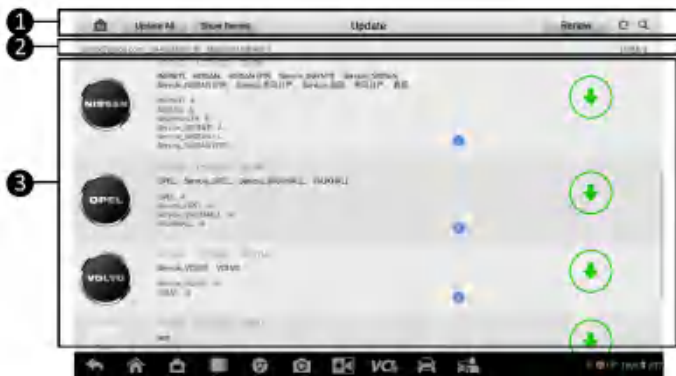

**Figure 9-1 Update Screen**

1. Navigation and Controls
  - Home Button — returns to the MaxiCOM Job Menu
  - Update All — updates all available updates
  - Show Recent — shows recent updates
  - Renew — displays expire date of the software. Tap on **Renew** button to extend subscription.
  - Refresh — refreshes interface
  - Search — searches a specific update item by entering the file name, for example: a specific vehicle make.
2. Status Bar
  - Left Side — displays the MaxiCOM device model information and serial number.

- Right Side — displays an update progress bar indicating the completion status.
3. Main Section
- Left Column — displays vehicle logos.
  - Middle Column — displays a brief introduction about the new changes to the software operation or capabilities. Tap the **i** button to view more details, and tap the dim area around to close the window.
  - Right Column — depending on the operation status of each software, the icon displays differently.
    - a) Tap the **Update** icon to update the selected item.
    - b) Tap the **Pause** icon to suspend the updating procedure.
    - c) Tap the **Continue** icon to continue updating the suspended update.

➤ **To update the software**

1. Power up the tablet, and ensure that it is connected to a power source and has a steady Internet connection.
2. Tap the **Update** application button from the MaxiCOM Job Menu; or tap the update notification when received. The Update application screen displays.
3. Check all available updates:
  - If you decide to update all the items, tap the **Update All** button.
  - If you only want to update some individual items, tap the **Update** icon on the right column of the specific item.
4. Tap the **Pause** icon to suspend the updating process. Tap the **Continue** icon to resume the update from the pause point.
5. When the updating process is completed, the software will be installed automatically. The new version will replace the old version.



# 10. VCI Manager

This application allows you to pair up the MaxiCOM tablet with the VCI, by either the J2534 Programming Device or the Wireless Diagnostic Interface, and to check the communication status.

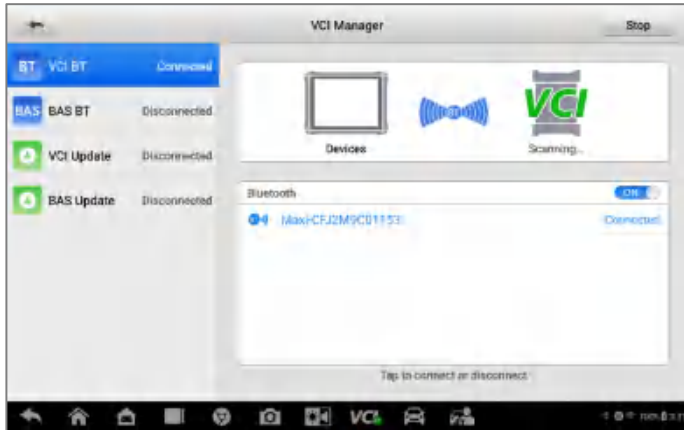

*Figure 10-1 VCI Manager Screen*

## VCI Bluetooth Pairing

The VCI needs to be either connected to a vehicle or power source, so that it is powered up during the synchronization procedure. Make sure the MaxiCOM tablet has a fully charged battery or is connected to an AC/DC power supply.

➤ **To pair the VCI with the tablet via Bluetooth**

1. Power on the tablet.
2. Connect the 26-pin end of the main cable to the J2534 ECU Programming Device's vehicle data connector (for MaxiCOM MK908 Pro II);  
Or connect the 15-pin end of the main cable to the Wireless Bluetooth Diagnostic Interface's vehicle data connector (for MaxiCOM MK908 II)
3. Connect the 16-pin end of the main cable to the vehicle Data Link Connector (DLC).
4. Tap the **VCI Manager** application on the MaxiCOM Job Menu of the tablet.
5. Select **VCI BT** from the connection mode list.

6. Toggle Bluetooth ON. The device will start searching for available units for pairing.
7. Depending on the VCI type you use, the device name may display as “Maxi” suffixed with a serial number. Select the required device for pairing.
8. When pairing is successfully done, the connection status reads as “Connected.”
9. Wait a few seconds, and the VCI button on the system Navigation bar at the bottom of the screen shall display a green tick icon, indicating the tablet is connected to the VCI.
10. Tap the **Back** button on the top left to return to the MaxiCOM Job Menu.

**NOTE**

A VCI can be paired to only one tablet each time, and once it is paired, the device will not be discoverable for any other unit.

## BAS Bluetooth Pairing

The MaxiBAS BT506 device needs to be either connected to a vehicle or to an available power source, so that it is powered up during the synchronization procedure. Make sure the tablet is fully charged or connected to an external power supply.

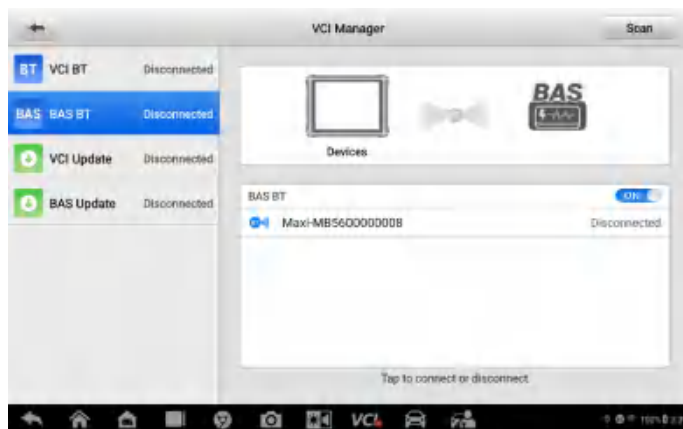

**Figure 10-2 Battery Tester Bluetooth Pairing Screen**

- **To pair the BT506 tester with the tablet**
  1. Press and hold the **Power/Lock** button to turn on the MaxiCOM tablet. Ensure that the unit is sufficiently charged before using.
  2. Power on the MaxiBAS BT506.
  3. Tap **VCI Manager** on the MaxiCOM Job Menu of the tablet.
  4. Select **BAS BT** from the connection mode list.

5. Toggle Bluetooth ON. The tablet automatically scans for an available battery tester for Bluetooth pairing. The device name will appear as “Maxi” suffixed with a serial number.
6. Check the serial number of your BT506 tester and select the desired device on the tablet for pairing.
7. When paired successfully, the connection status will read as “Connected.”
8. Tap the **Back** icon on the top-left to return to the MaxiCOM Job Menu.

## VCI Update

Before updating the VCI software, please make sure the MaxiCOM tablet network connection is stable.

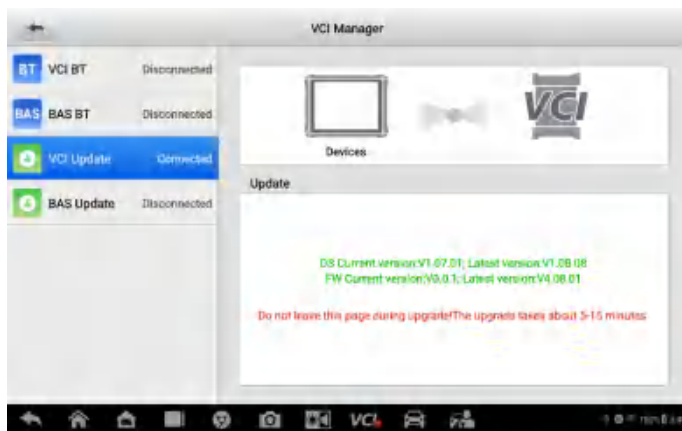

*Figure 10-3 VCI Update Screen*

### ➤ To update the VCI

1. Power on the MaxiCOM tablet.
2. Connect the VCI to MaxiCOM tablet via Bluetooth or USB.
3. Tap the **VCI Manager** application on the MaxiCOM Job Menu of the tablet.
4. Select **VCI Update** from the connection mode list.
5. The current version and the latest version of the VCI will be displayed after a few seconds. Tap **Update Now** to update the VCI.

# BAS Update

---

The BAS Update module provides the latest update for the MaxiBAS BT506. Before updating the BT506 tester, please make sure your tablet network is stable.



*Figure 10-4 BAS Update Screen*

➤ **To update the MaxiBAS BT506**

1. Power on the tablet and the MaxiBAS BT506.
2. Connect the MaxiBAS BT506 device to the tablet via Bluetooth or USB.
3. Tap **VCI Manager** on the MaxiCOM Job Menu of the tablet.
4. Select **BAS Update** from the connection mode list.
5. The current version and the latest version of the MaxiBAS BT506 will appear. Tap **Update Now** to update the MaxiBAS BT506.

# 11. Remote Desktop

The Remote Desktop application launches the TeamViewer Quick Support program, which is a simple, fast and secure remote-control interface. You can use the application to receive ad-hoc remote support from Autel's support center, colleagues, or friends, by allowing them to control your MaxiCOM tablet on their PC via the TeamViewer software.

## Operations

---

If you think of a TeamViewer connection as a phone call, the TeamViewer ID would be the phone number under which all TeamViewer Clients can be reached separately. Computers and mobile devices that run TeamViewer are identified by a globally unique ID. The first time the Remote Desktop application is started, this ID is generated automatically based on the hardware characteristics and will not change.

Make sure the tablet is connected to the Internet before launching the Remote Desktop application, so that the tablet is accessible to receive remote support from the third party.

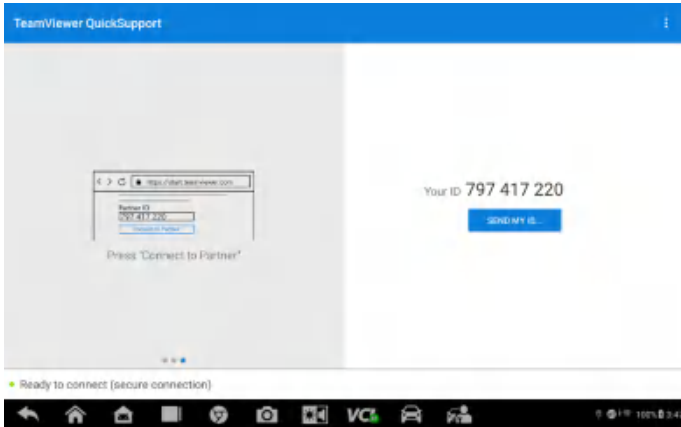

**Figure 11-1 Remote Desktop Screen**

➤ **To receive remote support from a partner**

1. Power on the tablet.
2. Tap the **Remote Desktop** application on the MaxiCOM Job Menu. The TeamViewer interface displays and the device ID is generated and shown.
3. Your partner must install the Remote Control software to his/her computer by downloading the TeamViewer full version program online (<http://www.teamviewer.com>), and then start the software on his/her computer at the same time, in order to provide support and take control of the tablet remotely.
4. Provide your ID to the partner, and wait for him/her to send you a remote control request.
5. A message displays to ask for your confirmation to allow remote control on your device.
6. Tap **Allow** to accept, or tap **Deny** to reject.

Refer to the associated TeamViewer documents for additional information.

# 12. Support

This application launches the Support platform which synchronizes Autel's online service base station with the MaxiCOM tablet. In order to synchronize the device to your online account, you need to register the product through the Internet when you use it for the first time. The Support application is connected to Autel's service channel and online communities that provides the quickest way for problem solutions, allowing you to submit complaints or send help requests to obtain direct service and support.

## Product Registration

---

In order to get access to the Support platform and obtain update and other services from Autel, you are required to register the MaxiCOM diagnostic device the first time you use it.

### ➤ To register the diagnostic device

#### Option One:

1. Visit the website: <http://pro.autel.com>.
2. If you have an Autel account, log in and skip to Step 7.
3. If you are a new member to Autel, click **Register** to create your Autel ID.
4. Enter your personal information. Fields marked with an asterisk (\*) are mandatory.
5. After all the mandatory information is entered, read the **Autel User Service Agreement** and **Autel Privacy Policy**, then check the box to accept the terms and click **Register**.
6. Once your account is successfully registered, you will be redirected to the Product Registration screen. If not, click the button on the screen.
7. Your product serial number and password are required to enter. To find your serial number and password on the tablet: go to **Settings > About**.
8. Enter your tablet's serial number and password.
9. Enter the CAPTCHA code and click **Submit** to complete your product registration.

#### Option Two:

1. Tap **Autel User Center** on the MaxiCOM Job Menu.
2. If you have an Autel account, input your email or mobile number and password

to log in or log in with verification code.

3. If you are a new member to Autel, click **Register** to create your Autel ID.
4. Enter your personal information. Fields marked with an asterisk (\*) are mandatory.
5. Read the **Autel User Service Agreement** and **Autel Privacy Policy**, then check the box to accept the terms.
6. After all the mandatory information is entered, click **Register**.
7. Once your account is successfully registered, your account will be logged in automatically.
8. Tap **Device Management** to link your device.
9. Tap **Link Device** on the upper-right corner of the screen.
10. The serial number and password of the device will be shown on the screen. Tap **Link** to complete the operation.

## Support Screen Layout

---

The main section of the Support screen is divided into two sections: The narrow column on the left is the main menu; selecting one subject from the main menu displays the corresponding function interface on the right.



*Figure 12-1 Support Application Screen*



## **My Account**

The My Account screen displays the comprehensive information of the user and the product, which is synchronized with the online registered account, including User Info, Device Info, Update Info, and Service Info.

### *Personal Info*

The User information and Device information are both included under the Personal Info section.

- User information — displays detailed information registered online Autel account, including your Autel ID, Real name, Country/District, Town/City, Company/Institute, Address, and Post code.
- Device information — displays the registered product information, including the Product serial number, Registration time, Expire time, and Warranty period.

### *Update Info*

The Update Info tab displays a detailed record list of the product's software update history, including the product serial number, software version or name, and the update time.

### *Service Info*

The Service Info tab displays a detailed record list of the device's service history information. Every time the device has been sent back to Autel for repair, the device's serial number and the detailed repair information, including Service date, Type of faults, and Repair content, will be recorded and updated to the associated online product account, which will be synchronized to the Service Info section.

## **Training**

The Training section provides quick links to Autel's online video library. Select a video channel by language to see all available Autel online tutorial videos on such topics as product usage techniques and vehicle diagnostics practices.

## **Data Logging**

The Data Logging screen keeps records of all Feedback (submitted), No feedback (saved) or History (up to the latest 20 test records) data loggings on the diagnostic system. The support personnel receive and process the submitted reports through the Support platform, and send back problem solutions within 48 hours to the corresponding Data Logging session, on which you are also allowed to have a direct conversation with the support personnel.



**Figure 12-2 Data Logging Screen**

➤ **To make a reply in a Data Logging session**

1. Tap **Feedback** to view the list of submitted data loggings.
2. Select a specific item to view the latest update of the processing progress.
3. Tap the text field at the bottom of the screen and enter the texts. Additionally, you may tap the **Audio** button to record a voice message or tap the **Camera** button to take a picture.
4. Tap **Send** to deliver your message to the technical center.

## FAQ

The FAQ section provides you with comprehensive and abundant references for all questions frequently asked and answered about the use of Autel’s online member account, shopping, and payment procedures.

- Account — displays questions and answers about the use of Autel’s online user account.
- Shopping — displays questions and answers about online product purchases.
- Payment — displays questions and answers about online payment methods or procedures.

# 13. Quick Link

The Quick Link application provides you with convenient access to Autel's official website and many other well-known sites in automotive service, which offers you abundant information and resources, such as technical help, knowledge base, forums, training, and expertise consultations.



*Figure 13-1 Quick Link Screen*

➤ **To open a quick link**

1. Tap the **Quick Link** application on the MaxiCOM Job Menu. The Quick Link application screen displays.
2. Select a website thumbnail from the main section. The Chrome browser is launched and the selected website is opened.
3. Now you can start exploring the website.

# 14. MaxiScope

The MaxiScope application configures the MaxiCOM Diagnostics Device to operate as an automotive oscilloscope when work in combination with the MaxiScope module. This function provides all the features needed for performing electrical and electronic circuit tests as well as monitoring signal activities on any modern vehicles, which shows you what is really going on with a vehicle's electrical system.

Please download the latest user manual for Autel MaxiScope device from [www.autel.com](http://www.autel.com) > **Specialty Tools** > **MORE PRODUCTS** > **MaxiScope MP408** > **Downloads**.

# 15. MaxiViewer

MaxiViewer allows you to search functions and the version information supported by our tools. There are two ways of searching, either by searching the tool and the vehicle or searching the functions.

## ➤ To search by the vehicle

1. Tap the **MaxiViewer** application on the MaxiCOM Job Menu. The MaxiViewer screen displays.
2. Tap the tool name on the top-left to drop down the tool list, and tap the one you want to search.
3. Tap the vehicle brand, model, and year you want to search.

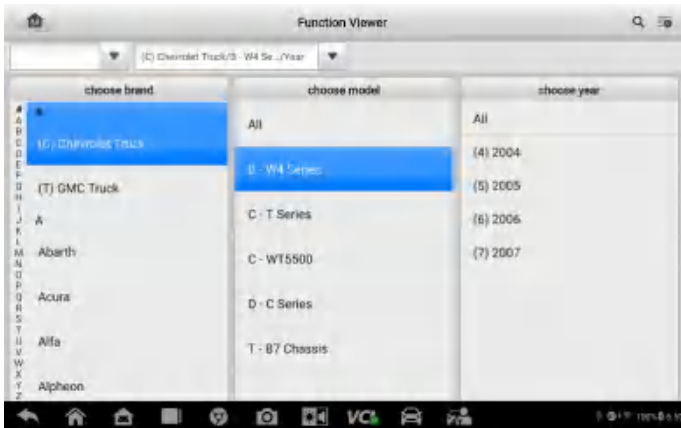

*Figure 15-1 MaxiViewer Screen 1*

4. All functions supported by the selected tool for the selected vehicle are displayed with vehicle's system, year, type, function, sub function, and version.



**Figure 15-2 MaxiViewer Screen 2**

➤ **To search by the functions**

1. Tap the **MaxiViewer** application on the MaxiCOM Job Menu. The MaxiViewer screen displays.
2. Tap the tool name on the top left to drop down the tool list and tap the one you want to search.
3. Enter the function you want to search in the top-right search box. The screen will display all vehicles that support this function, along with information such as the vehicles' year, system, capacity, type, function, sub-function, and version.

**NOTE**

Fuzzy search is supported: Type in any part of the function-related keywords to find all available information.

# 16. MaxiVideo

The MaxiVideo application configures the MaxiCOM diagnostics device to operate as a digital video scope by simply connecting the tablet to a MaxiVideo Camera. This function allows you to examine difficult-to-reach areas normally hidden from sight, with the ability to record digital still images and videos, which offers you an economical solution to inspect machinery, facilities, and infrastructure in a safe and quick way.

The MaxiVideo Camera and its fittings are the additional accessories for the user to purchase separately. Refer to the Quick Reference Guide of MaxiVideo for detailed operational instructions.

# 17. OEM Authorization

The OEM Authorization application allows to unlock the gateway ECU (CGW) for some vehicles to perform advanced diagnostics tests.

---

## NOTE

Make sure the tablet is connected to a stable network before launching the OEM Authorization application.

---

### ➤ To unlock the gateway ECU (CGW)

1. Connect the tablet to the vehicle.
2. Tap **Diagnostics** on the MaxiCOM Job Menu.
3. Tap **Renault** to select the vehicle type and tap **OK** to confirm the vehicle information.
4. Tap **Unlock** on the Information screen.
5. On the Purchase, tap **OK**. Select the purchase method and pay to unlock the gateway. On the Purchase Successfully screen, tap **OK**.
6. Exit the Diagnostics application. Tap **OEM Authorization** on the MaxiCOM Job Menu. On the OEM Authorization screen, tap **Renew**. The Unlocking Information screen appears, on which you can view the remaining service sessions.



# 18. Maintenance and Service

To ensure that the tablet and the combined VCI unit perform at their optimum level, we advise that the product maintenance instructions covered in this section is read and followed.

## Maintenance Instructions

---

The following shows instructions on how to maintain your devices, together with precautions to take.

- Use a soft cloth and alcohol or a mild window cleaner to clean the touch screen of the tablet.
- Do not use any abrasive cleansers, detergent, or automotive chemicals to the tablet.
- Maintain the devices in dry conditions and keep them within normal operating temperatures.
- Dry your hands before using the tablet. The touch screen of the tablet may not work if the touch screen is moist, or if you tap the touch screen with wet hands.
- Do not store the devices in humid, dusty or dirty areas.
- Check the housing, wiring, and connectors for dirt and damage before and after each use.
- At the end of each work day, wipe the device housing, wiring, and connectors clean with a damp cloth.
- Do not attempt to disassemble your tablet or the VCI unit.
- Do not drop or cause severe impact to the devices.
- Use only authorized battery chargers and accessories. Any malfunction or damage caused by the use of unauthorized battery charger and accessories will void the limited product warranty.
- Ensure that the battery charger does not come in contact with conductive objects.
- Do not use the tablet beside microwave ovens, cordless phones and some medical or scientific instruments to prevent signal interference.

# Troubleshooting Checklist

---

## A. When the tablet does not work properly:

- Make sure the tablet has been registered online.
- Make sure the system software and diagnostic application software are properly updated.
- Make sure the tablet is connected to the Internet.
- Check all cables, connections, and indicators to see if the signal is being received.

## B. When battery life is shorter than usual:

- This may happen when you are in an area with low signal strength. Turn off your device if is not in use.

## C. When you cannot turn on the tablet:

- Make sure the tablet is connected to a power source or the battery is charged.

## D. When you are unable to charge the tablet:

- Your charger maybe out of order. Contact your nearest dealer.
- You may be attempting to use the device in an overly hot/cold temperature. Charge the device in a cooler or warmer area.
- Your device may have not been connected to the charger properly. Check the connector.

---

### NOTE

If your problems persist, please contact Autel's technical support personnel or your local selling agent.

---

## About Battery Usage

---

Your tablet is powered by a built-in Lithium-ion Polymer battery. This means that, unlike other forms of battery technology, you can recharge your battery while some charge remains without reducing your tablet's autonomy due to the "battery memory effect" inherent in those technologies.

---

### DANGER

The built-in Lithium-ion Polymer battery is factory replaceable only; incorrect replacement or tampering with the battery pack may cause an explosion.

---

- Do not use a damaged battery charger.
- Do not disassemble or open crush, bend or deform, puncture or shred.
- Do not modify or remanufacture, attempt to insert foreign objects into the battery, expose to fire, explosion or other hazard.
- Use only the included charger and USB cables. Failure to use Autel-authorized charger and/or USB cables, may result in device malfunction or failure.
- Use of an unqualified battery or charger may present a risk of fire, explosion, leakage, or another hazard.
- Avoid dropping the tablet. If the tablet is dropped, especially on a hard surface, and the user suspects damage, take it to a service center for inspection.
- The closer you are to your network's wireless router, the longer your tablet usage time because less battery power is consumed for the connection.
- The battery recharging time varies depending on the remaining battery capacity.
- Battery life inevitably shortens over time.
- Since overcharging may shorten battery life, remove the tablet from its charger once it is fully charged. Unplug the charger, once charging is complete.
- Leaving the tablet in hot or cold places, especially inside a car in summer or winter, may reduce the capacity and life of the battery. Always keep the battery within normal temperatures.

## Service Procedures

---

This section introduces information for technical support, repair service, and application for replacement or optional parts.

### Technical Support

If you have any question or problem on the operation of the product, please contact us.

#### North America

- **Phone:** 1-855-AUTEL-US (288-3587) (Monday-Friday, 9AM-9PM Eastern Time)
- **Fax:** (631) 357-3304
- **Email:**  
Tech Support: [ussupport@autel.com](mailto:ussupport@autel.com);  
Sales: [sales@autel.com](mailto:sales@autel.com);  
Careers: [careers@autel.com](mailto:careers@autel.com)
- **Address:** 36 Harbor Park Drive, Port Washington, New York, USA 11050
- **Web:** [www.autel.com](http://www.autel.com)

## Europe

- **Phone:** +49(0)89 540299608 (Monday-Friday, 9:00AM-6:00PM Berlin Time)
- **Email:** [support.eu@autel.com](mailto:support.eu@autel.com)
- **Address:** Landsberger Str. 408, 4. OG, 81241 München, Germany
- **Web:** [www.autel.eu](http://www.autel.eu)

## China Headquarters

- **Phone:** 0086-755-2267-2493 (Monday-Friday, 9:00AM-6:00PM Beijing Time)
- **Email:** [sales@auteltech.net](mailto:sales@auteltech.net); [support@autel.com](mailto:support@autel.com)
- **Address:** 7th, 8th and 10th Floor, Building B1, Zhiyuan, Xueyuan Road, Xili, Nanshan, Shenzhen, 518055, China
- **Fax:** 0086-755-8614-7758
- **Web:** [www.auteltech.cn](http://www.auteltech.cn)

## Autel Latin America

- **Phone:** +52 33 1001 7880 (Spanish in Mexico), +55 19 97816 4911 (Portuguese in Brazil)
- **Email:** [latsupport@autel.com](mailto:latsupport@autel.com) (in Mexico); [brsupport@autel.com](mailto:brsupport@autel.com) (in Brazil)
- **Address:** Avenida Americas 1905, 6B, Colonia Aldrete, Guadalajara, Jalisco, Mexico
- **Web:** [www.autel.com](http://www.autel.com)

## Autel APAC

- **Phone:** +81-045-548-6282 (in Japan)
- **Email:** [sales.jp@autel.com](mailto:sales.jp@autel.com); [support.jp@autel.com](mailto:support.jp@autel.com)
- **Address:** 719, Nissou Building, 3-7-18, Shinyokohama, Kouhoku, Yokohama, Kanagawa, Japan 222-0033
- **Web:** [www.autel.com/jp/](http://www.autel.com/jp/)

## Autel IMEA DMCC

- **Phone:** +971 585 002709
- **Email:** [sales.imea@autel.com](mailto:sales.imea@autel.com); [imea-support@autel.com](mailto:imea-support@autel.com)
- **Address:** 906-17, Preatoni Tower (Cluster L), Jumeirah Lakes Tower, DMCC, Dubai, UAE
- **Web:** [www.autel.com](http://www.autel.com)

For technical assistance in other markets, please contact your local selling agent.

## Repair Service

If it becomes necessary to return your device for repair, please download the repair service form from [www.autel.com](http://www.autel.com), and fill in the form. The following information must be included:

- Contact name
  - Return address
  - Telephone number
  - Product name
  - Complete description of the problem
  - Proof-of-purchase for warranty repairs
  - Preferred method of payment for non-warranty repairs
- 

### NOTE

For non-warranty repairs, payment can be made with Visa, Master Card, or with approved credit terms.

---

Send the device to your local agent, or to the below address:

8th Floor, Building B1, Zhiyuan, Xueyuan Road, Xili, Nanshan, Shenzhen, 518055, China

## Other Services

You can purchase the optional accessories directly from Autel's authorized tool suppliers, and/or your local distributor or agent.

Your purchase order should include the following information:

- Contact information
- Product or part name
- Item description
- Purchase quantity

# 19. Compliance Information

## FCC Compliance

FCC ID: WQ8-IM608PRO2121

This equipment has been tested and found to comply with the limits for a Class B digital device, pursuant to Part 15 of the FCC Rules. These limits are designed to provide reasonable protection against harmful interference in a residential installation. This equipment generates uses and can radiate radio frequency energy and, if not installed and used in accordance with the instructions, may cause harmful interference to radio communications. However, there is no guarantee that interference will not occur in a particular installation. If this equipment does cause harmful interference to radio or television reception, which can be determined by turning the equipment off and on, the user is encouraged to try to correct the interference by one or more of the following measures:

- Reorient or relocate the receiving antenna.
- Increase the separation between the equipment and receiver.
- Consult the dealer or an experienced radio/TV technician for help.

This device complies with part 15 of the FCC Rules. Operation is subject to the following two conditions:

- 1) This device may not cause harmful interference, and
- 2) this device must accept any interference received, including interference that may cause undesired operation.

Changes or modifications not expressly approved by the party responsible for compliance could void the user's authority to operate the equipment.

## SAR:

The radiated output power of this device is below the FCC radio frequency exposure limits. Nevertheless, the device should be used in such a manner that the potential for human contact is minimized during normal operation.

The exposure standard for wireless devices employs a unit of measurement known as the Specific Absorption Rate, or SAR. The SAR limit set by the FCC is 1.6 W/Kg. Tests for SAR are conducted using standard operating positions accepted by the FCC with the device transmitting at its highest certified power level in all tested frequency bands. Although the SAR is determined at the highest certified power level, the actual SAR level of the device while operating can be well below the maximum value. This is because the

device is designed to operate at multiple power levels so as to use only the power required to reach the network. To avoid the possibility of exceeding the FCC radio frequency exposure limits, human proximity to antenna should be minimized.

CE Compliance

RED Directive 2014/53/EU

RoHS Compliance

This device is declared to be in compliance with the European RoHS Directive 2011/65/EU.

# 20. Warranty

## 12-month Limited Warranty

---

Autel Intelligent Technology Corp., Ltd. (the Company) warrants to the original retail purchaser of this MaxiCOM Diagnostics Device that should this product or any part thereof during normal usage and under normal conditions be proven defective in material or workmanship that results in product failure within twelve (12) months period from the date of purchase, such defect(s) will be repaired, or replaced (with new or rebuilt parts) with Proof of Purchase, at the Company's option, without charge for parts or labor directly related to the defect(s).

The Company shall not be liable for any incidental or consequential damages arising from the use, misuse, or mounting of the device. Some states do not allow limitation on how long an implied warranty lasts, so the above limitations may not apply to you.

**This warranty does not apply to:**

- a) Products subjected to abnormal use or conditions, accident, mishandling, neglect, unauthorized alteration, misuse, improper installation or repair or improper storage;
- b) Products whose mechanical serial number or electronic serial number has been removed, altered or defaced;
- c) Damage from exposure to excessive temperatures or extreme environmental conditions;
- d) Damage resulting from connection to, or use of any accessory or other product not approved or authorized by the Company;
- e) Defects in appearance, cosmetic, decorative or structural items such as framing and non-operative parts.
- f) Products damaged from external causes such as fire, dirt, sand, battery leakage, blown fuse, theft or improper usage of any electrical source.

---

**❗ IMPORTANT**

All contents of the product may be deleted during the process of repair. You should create a back-up copy of any contents of your product before delivering the product for warranty service.

---